

SHRINK-FIT HOLDER
SLIMLINE

PAT.

MONO **CURVE**



Optimum tool holder for
5-axis machining center
SHRINK-FIT HOLDER
SLIMLINE MONO **CURVE**



Der optimale Werkzeughalter für
5-Achsen-Bearbeitungszentren
SCHRUMPFHALTER
SLIMLINE MONO **CURVE**



Portautensile ottimale per centro di
lavoro a 5 assi supporto
shrink-fit SLIMLINE MONO **CURVE**



Mandrin de frettage optimisé
pour centre d'usinage 5 axes
PORTE-OUTIL A AJUSTEMENT FRETTE
SLIMLINE MONO **CURVE**

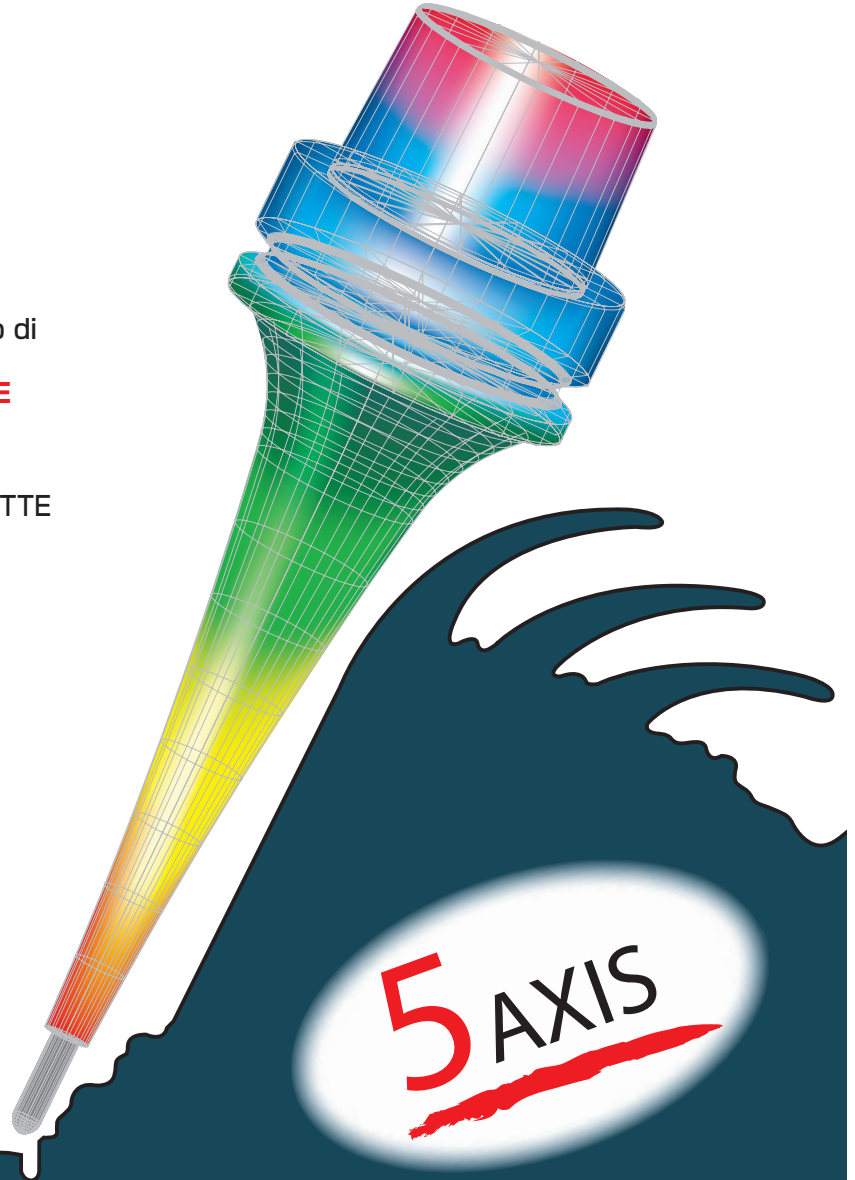

MST corporation



1107EU

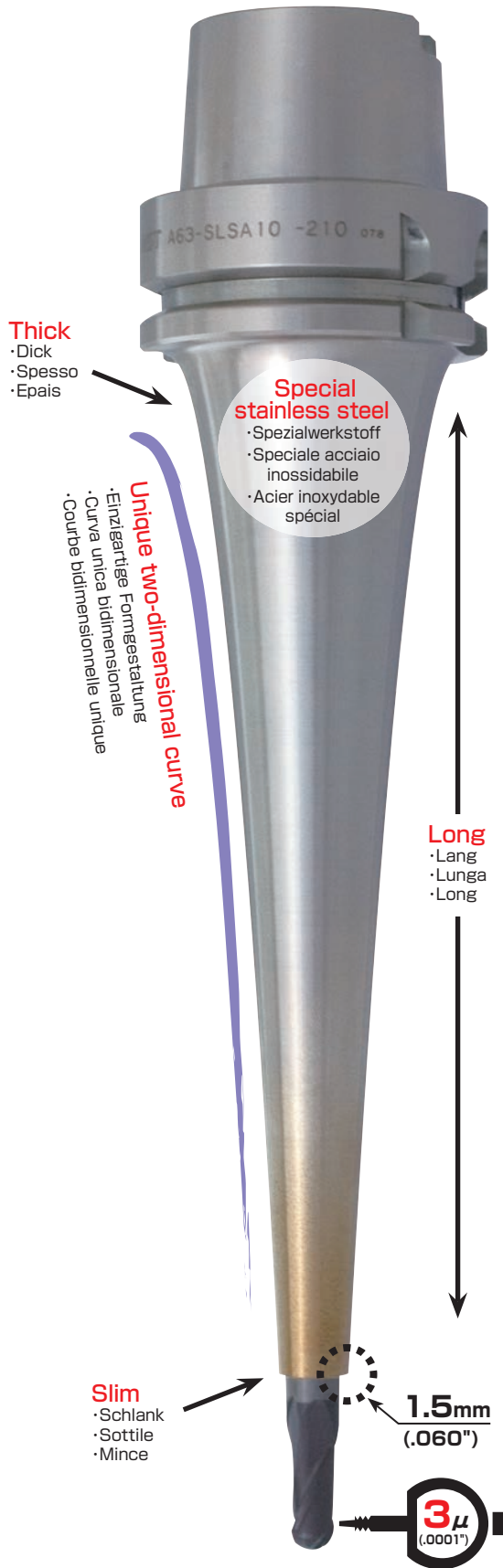

Collet holder, Milling chucks

- Pinza portautensili, Mandrino fresa
- Porte-pince, Mandrin de fraisage
- Spannanzgenhalter, Fräsfutter

SLIMLINE MONO CURVE

High rigidity

Hohe Steifigkeit
Haute rigidité

Elevata rigidità

Interference

- Interférences
- Collisions
- Störfaktor

Special design tapernecked end-mill

- Spezialdesign konusfräser
- Fresa frontale a collo conico con design speciale
- Fraise conique spéciale

Standard cutting tool

- Standard-werkzeug
- Utensile di taglio standard
- Outil standard

Minimum overhang

- Minimaler Überhang
- Minima sporgenza
- Sortie minimale

Strong clamping force

Hohe Spannkraft

Sicura forza di serraggio

Grande force de serrage

21N·m (2.1kgf·m)

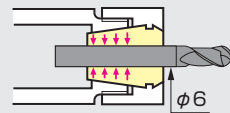

Elastic deformation

- Elastische Verformung
- Deformazione elastica
- Deformation elastique

3 times
Das 3-fache
3 volte
3 fois

62N·m (6.2kgf·m)

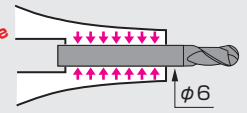

Thermal expansion → Shrinkage Force

- Wärmedehnung → Aufschumpfkraft
- Espansione termica → Forza di serraggio
- Dilatation thermique → Force de serrage

Added new variety

Zusätzliche neue Varianten

Nuovo tipo aggiunto

Nouveau type ajouté

Slim type

- Schlanke Ausführung
- Sottile
- Type Slim

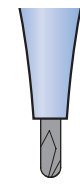

1.5mm
(.060")

Regular type

- Normale Ausführung
- Standard
- Type Regular

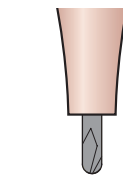

3~5mm
(.118~.197")

Flush type

- Ausführung für Kühlmittelzufuhr
- Con fori per flusso refrigerante
- Type Flush

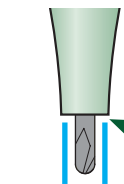

3~5mm
(.118~.197")

High accuracy

Höchste Rundlaufgenauigkeit

Elevata precisione

Très grande précision de faux-rond



The optimum holder shape for 5-axis machining is as slim a design as possible in the tip. In addition, rigidity is important even if the neck of the holder is thick and long. The SLIMLINE MONO CURVE achieves such an ideal holder design for 5-axis machining with its unique secondary curve.



Der optimale Halter für die 5-Achsen-Bearbeitung hat eine möglichst schlanke Spitze. Zudem sollte er besonders steif sein, auch wenn der Ansatz des Halters lang und dick ist. Mit seiner einzigartigen Sekundärkurve hat der SLIMLINE MONO CURVE praktisch die Idealform für die 5-Achsen-Bearbeitung.



Il portautensili ottimale per la lavorazione a 5 assi ha un design particolarmente sottile della punta. Anche la rigidità risulta essere importante, anche se il collo del portautensili è spesso e lungo. Grazie alla sua curva secondaria straordinaria, SLIMLINE MONO CURVE ha la forma ideale per la lavorazione a 5 assi.



Le porte outil avec la forme optimale pour l'usage 5 axes. Le SLIMLINE MONO CURVE a un bout le plus fin possible tout en ayant une rigidité très importante, ceci grâce une courbure du corps unique.

UK 5-axis machining center - Axis control type.

DE 5-Achsen-Bearbeitungszentrum - Achsensteuerungstyp.

IT Centri di lavoro a 5 assi - Tipo di controllo assi.

FR Centres d'usinage 5 axes - Type de commande d'axe.

5-axis control

- 5-Achsen-Steuerung
- Controllo a 5 assi
- Commande 5 axes



3-axis straight movement (X,Y,Z)

- 3-Achsen-Linearbewegung
- Movimento dritto a 3 assi
- Déplacement droit 3 axes



2-axis Table positioning (A,C)

- 2-Achsen-Tischpositionierung
- Posizionamento tavola a 2 assi
- Positionnement de la table 2 axes

Table Tilt type

- Dreh-/Kipptisch-Ausführung
- Tipo con ribaltamento tavola
- Modèle avec diviseur inclinable

- Small size work-piece
- Kleines Werkstück
- Pezzo di piccole dimensioni
- Pièce de petite taille

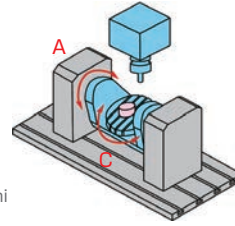

Head Tilt type

- Gabelkopf -Ausführung
- Tipo con ribaltamento testa
- Modèle avec tête inclinable

- Large size work-piece
- Grosses Werkstück
- Pezzo di grandi dimensioni
- Pièce de grande taille

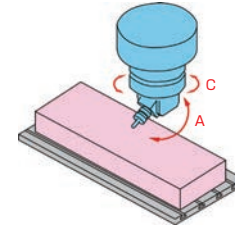
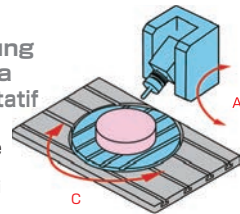

Table • Head Tilt type

- Drehtisch/Schwenkkopf Ausführung
- Tipo con ribaltamento tavola • testa
- Modèle avec tête orientable et plateau rotatif

- Medium size work-piece
- Mittelgrosses Werkstück
- Pezzo di medie dimensioni
- Pièce de taille moyenne



UK Case study

DE Fallstudie

IT Studio analitico

FR Cas pratique

Simultaneous 5-axis machining

- Simultane 5-Achsen-Bearbeitung
- 5 assi simultanei
- Usinage simultané 5 axes

Simultaneous 5-axis machining is suitable for complicated 3D geometry work-pieces.

- Simultane 5-Achsen-Bearbeitung ist geeignet für Werkstücke mit komplizierten geometrischen 3D-Formen.
- La lavorazione a 5 assi simultanei è adatta per pezzi tridimensionali dalla geometria complessa.
- L'usinage simultané 5 axes est adapté aux pièces géométriques 3D compliquées.



- Aviation components**
- Luftfahrtkomponenten
 - Componenti dell' aviazione
 - Composants pour l' aviation



- Blisk**
- Propeller/Turbine
 - Blisk
 - Turbine

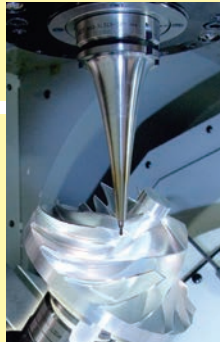

- Medical components**
- Medizinaurüstung
 - Componenti medici
 - Composants médicaux



- Artificial bone**
- künstliche Hüftgelenke
 - Osso artificiale
 - Os artificiel



- Artificial joint**
- Hüftprothesen
 - Giunto artificiale
 - Prothèse orthopédique

2 + 3-axis machining

- 2 + 3-Achsen-Bearbeitung
- Lavorazione a 2+3 assi
- Usinage 2+3 axes

Indexing a work piece by rotating and tilting 2-axis table, a spindle works with using 3-axis straight movement.

- Bei Anwendungen mit einem Dreh-Kipptisch arbeitet die Frässpindel in linearen 3-Achs-Bewegungen.
- Indexaggio di un pezzo mediante rotazione e ribaltamento della tavola a 2 assi, un mandrino lavora con la movimentazione dritta di 3 assi.
- Indexage d'une pièce en tournant et en inclinant la table 2 axes, la broche fonctionne lors du déplacement droit 3 axes.

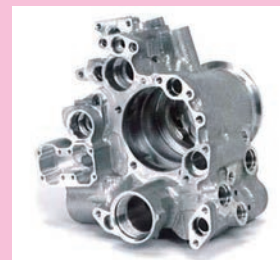

- Complicated geometry components**
- komplizierte geometrische Formen
 - Componenti dalla geometria complessa
 - Pièces avec géométries compliquées



- Injection mold**
- Spritzgiessform
 - Fillera ad iniezione
 - Moule d' injection

The optimum tool holder design for 5-axis machining.

 Der perfekte Halter für 5-Achsen-Anwendungen.

 Design ottimale del portautensile per la lavorazione a 5 assi.

 Conception de porte-outil optimale pour l'usinage 5 axes.

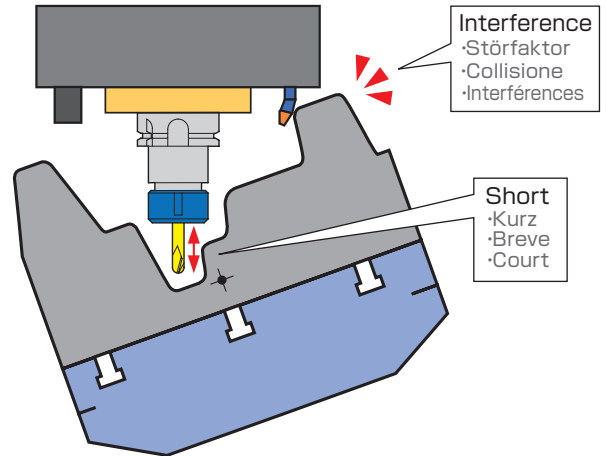
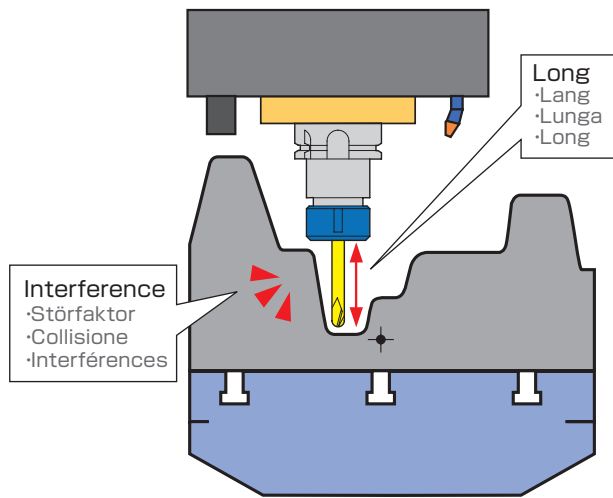

Deep cavity • Steep wall

3-axis machining

- Longer cutter projection is required in deep cavity or steep wall machining in order to avoid an interference in 3-axis machining..

5-axis machining

- It becomes less interference of tool holder and cutter projection shorter in 5-axis machining because of freely tilting a work-piece by rotating and tilting 2-axis table.
- Instead of this advantage, it creates an interference between spindle nose and work-piece.

Tiefenbearbeitung ohne Ausformschräge

3-Achsen-Bearbeitung

- Bei Tiefenbearbeitungen ohne grössere Ausformschräge sind lange Werkzeugauskragungen nötig, um Kollisionen während der 3-Achsen-Bearbeitung zu vermeiden.

5-Achsen-Bearbeitung

- Bei 5-Achsen-Bearbeitungen wird eine kürzere Werkzeugauskragung ermöglicht, da die Werkstücke frei bewegbar sind.....
- Jedoch entsteht ein Störfaktor zwischen Spindel-nase und Werkstück.

Parete ripida a cavità profonda

Lavorazione a 3 assi

- Nella lavorazione di pareti ripide o a cavità profonda è richiesta una sporgenza di taglio più lunga onde evitare interferenze nella lavorazione a 3 assi.

Lavorazione a 5 assi

- Il rischio di collisione del portautensile diventa minore e la sporgenza dell' utensile più corta nella lavorazione a 5 assi a causa del ribaltamento libero di un pezzo mediante rotazione e ribaltamento del tavolo a 2 assi.
- Invece di questo vantaggio, si crea una collisione tra la punta del mandrino e il pezzo.

Cavité profonde Parois raide

Usinage 3 axes

- Une sortie d' outil de coupe plus longue est nécessaire lors de l' usinage de cavité profonde ou de parois raide pour éviter une interférence lors de l' usinage 3 axes

Usinage 5 axes

- L' interférence du porte-outil diminue et la sortie de l' outil est plus courte lors de l' usinage 5 axes du fait de l' inclinaison libre d' une pièce en tournant et en inclinant la table 2 axes.
- Au lieu de cet avantage, une interférence est générée entre le nez de broche et la pièce.

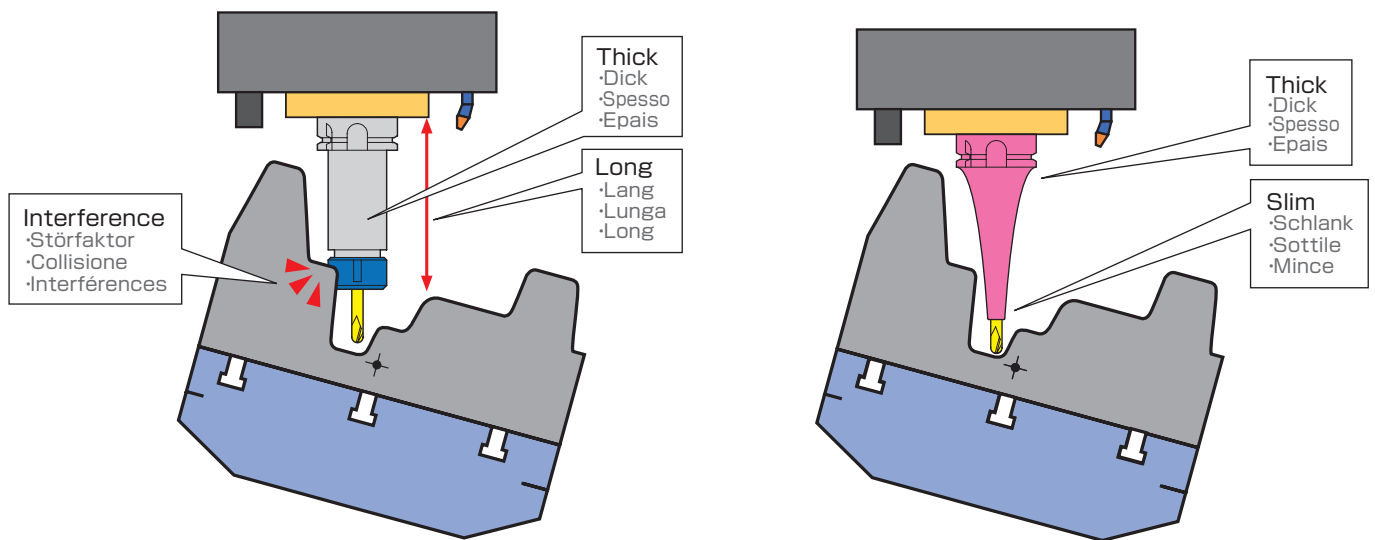

- To avoid this interference, 5-axis machining inevitably requires longer tool set-up (Tool holder + cutting tool).
- With commonly used collet holder and milling chucks, the nose of the holder is larger and more likely to interfere.

Optimum tool holder design

- The tool holder which has remarkable slim nose and rigid base design achieves super rigidity even long gauge length.

- Zur Kollisionsvermeidung benötigen 5-Achsenbearbeitungen zwangsläufig längere Einrichtungen (Halter + Schneidwerkzeug).
- Bei normalen Spannzangenhaltern und Fräserfuttern ist die Spannmutter grösser und daher ein wahrscheinlicher Störfaktor.

Optimales Halterdesign

- Der ideale Halter mit bemerkenswert schlankem Ansatz und stabilem Basisdesign erreicht höchste Steifigkeit trotz grosser Zuglänge.

- Per evitare questa collisione, la lavorazione a 5 assi richiede inevitabilmente una regolazione più lunga dell' utensile (portautensile+utensile di taglio).
- Con i comuni portapinza e gli autocentranti di fresatura, la punta del supporto è più grande e più facile che vada in collisione.

Design ottimale del portautensile

- Il portautensile, dotato di una punta e un design notevolmente piccoli, raggiunge una rigidità eccezionale anche se la lunghezza di sezione è grande.

- Pour éviter cette interférence, l' usinage 5 axes requiert inévitablement un réglage d' outil plus long (porte-outil + outil d' usinage).
- Le diamètre en bout des porte-pince ou des mandrins de fraisage utilisés est plus grand et a plus de chances d'interférer.

Conception de porte-outil optimale

- Le mandrin de frettage à bout mince de conception unique conserve une très grande rigidité même avec une jauge de grande longueur.

UK **Rigidity(Deflection)**

DE **Steifigkeit (Durchbiegung)**

IT **Elevata rigidità (Flessione)**

FR **Rigidité (déflexion)**

UK Calculating formula of deflection amount	DE Durchbiegungsgrad-Kalkulationsschema	IT Formula di calcolo della quantità di flessioni	FR Formule pour le calcul de la valeur de déflexion
--	--	--	--

Deflection amount is proportional to the cube of length.	Durchbiegungsgrad steigt proportional zum Längenkubus.	La quantità di flessioni è proporzionale al cubo della lunghezza.	La valeur de déflexion est proportionnelle au cube de longueur.
--	--	---	---

$$S = \frac{6.8 \times F \times L^3}{E \times D^4}$$

Deflection amount is inversely proportional to the fourth power of diameter.	Durchbiegungsgrad ist umgekehrt proportional zum bi-quadratischen Durchmesser.	La quantità di flessioni è inversamente proporzionale alla quarta potenza del diametro.	La valeur de déflexion est inversement proportionnelle à la quatrième puissance du diamètre.
--	--	---	--

S : Deflection amount	S : Durchbiegungsgrad	S : Quantità di deflessione	S : valeur de déflexion
D : Shank diameter	D : Schaftdurchmesser	D : Diametro albero	D : diamètre de queue
L : Projection	L : Überhang	L : Lunghezza della sporgenza	L : Sortie
F : Load	F : Schneidendruck	F : Carico	F : Force
E : Young's module	E : Modul Young	E : Modulo di Young	E : module de Young

1 Deflection 8 times
 •8-fache Durchbiegung
 •Flessioni moltiplicate per 8
 •Déflexion 8 fois

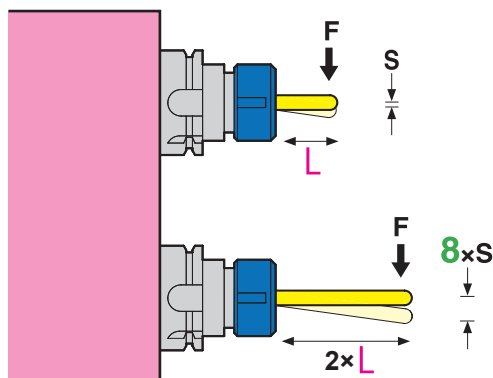

UK Diameter is same, cutter projection is twice.

DE Gleicher Durchmesser, 2-facher Überhang.

IT Il diametro è uguale, la sporgenza dell' utensile è doppia.

FR Le diamètre est identique, la sortie de l' outil est multipliée par 2

2 Deflection 16 times
 •16-fache Durchbiegung
 •Flessioni moltiplicate per 16
 •Déflexion 16 fois

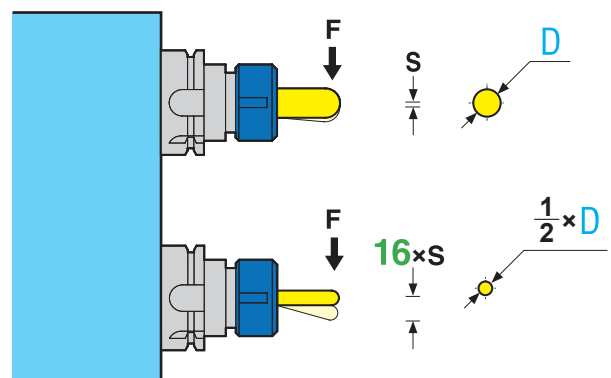

UK Cutter projection is same, diameter is half.

DE Gleicher Überhang, halber Durchmesser.

IT La sporgenza dell' utensile è uguale, il diametro è la metà.

FR La sortie de l' outil est identique , le diamètre est deux fois plus petit.

Short overall length end-mill for shrink-fit holder.

Fräser mit kurzer Gesamtlänge für Schrumpfhalter.

Fresa frontale a lunghezza breve integrale per supporto shrink-fit.

Fraise à queue courte pour le porte-outil à frotter.

The short overall length end-mill for shrink-fit tool holder which has short cutter shank, short cutting flute is provided by manufacturers below.

Fresa frontale a lunghezza breve integrale per supporto shrink-fit con codolo di taglio breve, la scanalatura di taglio breve è offerta dai produttori in basso.

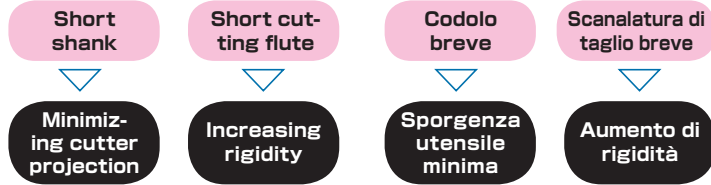

Fräser mit kurzer Gesamtlänge für Schrumpfhalter und kurzer Schneide sind von den unten angegebenen Herstellern lieferbar.

Les fabricants ci-dessous proposent des fraise à queue courte pour les porte-outil à frotter.

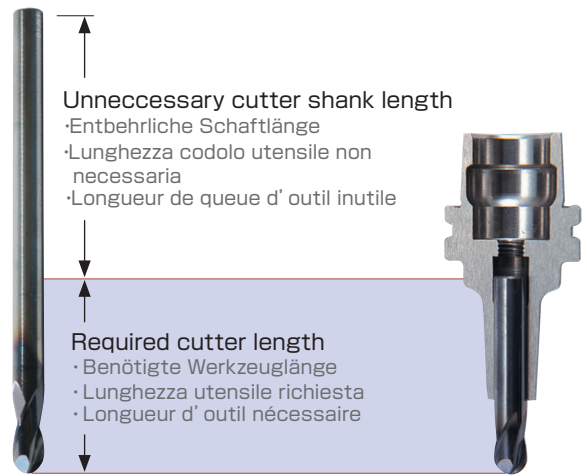
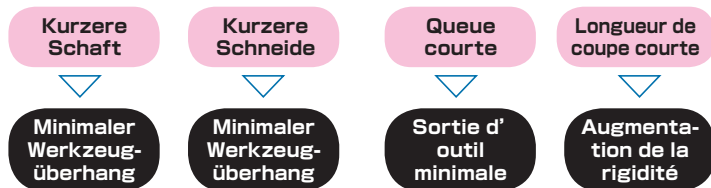

Standard end-mill
 · Standardfräser
 · Fresa frontale standard
 · Fraise à queue standard

Short overall length end-mill for shrink-fit tool holder
 · Fräser mit kurzer Gesamtlänge für Schrumpfaufnahme
 · Fresa frontale a lunghezza breve integrale per portautensile shrink-fit
 · Fraise à queue de longueur totale courte pour le porte-outil à ajustement fretté

MITSUBISHI MATERIALS

MITSUBISHI
 MITSUBISHI MATERIALS

VF-2SSB

Impact miracle ball end mill
 · Impact Miracle-Kugelschaftfräser
 · Fresa frontale con testa sferica Impact miracle
 · Fraise à queue à bille à impact miracle



UNION TOOL

UNION TOOL

HFB-S

High-efficiency short shank ball
 · Hocheffizienter Kugelschaftfräser mit kurzem Schaft
 · Fresa frontale con testa sferica e codolo corto di alta efficienza
 · Fraise à bout hémisphérique à grand rendement



DIJET INDUSTRIAL

DIJET

DZ-SSB

Super shot ball end mill
 · Super Shot-Kugelschaftfräser
 · Fresa frontale con testa sferica Super shot
 · Fraise à bout hémisphérique extra courte



MITSUBISHI HITACHI TOOL

三菱日立ツール
 Mitsubishi Hitachi Tool

FSHB-TH

Shrink master ball
 · Schrumpf-Masterkugel
 · Sfera campione a calettamento a caldo
 · Fraise à bout hémisphérique pour frettage



NS TOOL

NS

MSB230SF

Short shank ball end mill
 · Kugelschaftfräser mit kurzem Schaft
 · Fresa frontale con testa sferica e codolo corto
 · Fraise à bout hémisphérique courte



OSG

OSG

WXL-HS-EBD
WXL-HS-LN-EBD

Short overall length type WXL end mill
 · WXL-Schaftfräser mit kurzer Gesamtlänge
 · Fresa frontale di tipo WXL con lunghezza compressiva corta
 · Fraise à queue type WXL longueur totale courte



SLIMLINE rigidity calculation software



SLIMLINE Software zur Berechnung der statischen Steifigkeit

SLIMLINE software di calcolo della rigidità statica

Logiciel de calcul de rigidité SLIMLINE

Indispensable for CAM operators! **Free of charge**

Free of charge

- Für CAM-Bediener unerlässlich!
- Indispensabile per gli operatori CAM!
- Indispensable pour les opérateurs de CAO!
- Kostenlos
- Gratuito
- Sans frais

Automatically selects high-rigidity holder

The SLIMLINE rigidity value calculation software can easily check both the rigidity and the workpiece interference when a tool is mounted on the SLIMLINE. You can select the optimum holder having high rigidity and no machining interference. SLIMLINE offers the optimum holder, tool and tool projection and to help you achieve increased machining efficiency and high-quality machined surfaces.

- Optimum SLIMLINE
- + tool
- + tool projection

Automatische Wahl eines hochsteifen Halters

Anhand der SLIMLINE-Steifigkeitsberechnungssoftware können bei Einspannung eines Werkzeugs in den SLIMLINE-Halter sowohl die Steifigkeit als auch mögliche Kollisionen mit dem Werkstück kontrolliert werden. Der optimale Halter kann gewählt werden - ein Halter, der besonders steif ist und bei dem kein Kollisionsrisiko während der Bearbeitung besteht. SLIMLINE bietet die optimale Kombination aus Halter, Werkzeug und Werkzeugauskrantung und ermöglicht Ihnen so die Steigerung Ihrer Bearbeitungseffizienz und die Fertigung von Qualitätsflächen.

- SLIMLINE
- + Werkzeug
- + Werkzeugauskrantung: die optimale Kombination

Seleziona automaticamente il portautensili di grande rigidità

Il software per il calcolo del valore di rigidità di SLIMLINE può controllare facilmente sia la rigidità che le interferenze del pezzo quando un utensile è installato in SLIMLINE. È quindi possibile selezionare il portautensili ottimale, particolarmente rigido che non presenti interferenze durante la lavorazione. SLIMLINE offre una combinazione ottimale di portautensile, utensile e sporgenza dell' utensile e contribuisce ad ottenere una maggiore efficienza di lavorazione e superfici lavorate di alta qualità.

- SLIMLINE
- + utensile
- + sporgenza utensile: la combinazione ottimale

Sélectionne automatiquement un porte-outils à grande rigidité

Le logiciel de calcul de valeur de rigidité SLIMLINE peut facilement contrôler la rigidité et l'interférence de pièce lorsqu'un outil est monté sur SLIMLINE. Vous pouvez sélectionner le porte-outil optimal avec une grande rigidité et aucune interférence d'usinage. SLIMLINE est le porte-outils, outil et projection d'outil idéal qui vous aide à obtenir une efficacité d'usinage supérieure ainsi que des surfaces usinées de grande qualité.

- SLIMLINE
- + outil
- + projection d'outil optimum



High rigidity

- Hohe Steifigkeit
- Elevata rigidità
- Haute rigidité

Major dimensions are displayed.

- Die wichtigen Abmessungen werden angezeigt.
- Sono indicate le dimensioni più importanti.
- Les dimensions majeures sont affichées.

The optimum high-rigidity SLIMLINE is automatically selected.

- Die Wahl des optimalen, hochsteifen Halters erfolgt automatisch.
- Il portautensili SLIMLINE ottimale di elevata rigidità è selezionato automaticamente.
- La grande rigidité optimum de SLIMLINE est sélectionnée automatiquement.

Shape data (DXF or CSV format) is output.

- Die Konturdaten werden ausgegeben (im DXF- oder CSV-Format).
- Sono emessi i dati relativi alla forma (formato DXF o CSV)
- Les données de forme (au format DXF ou CSV) sont sorties.

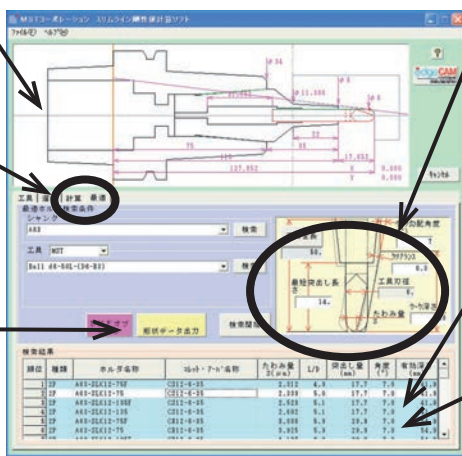

Input the workpiece shape, clearance, and tool projection.

- Werkstückkontur, Spiel und Werkzeugauskrantung eingeben.
- Introdurre la forma del pezzo, il gioco e la sporgenza dell'utensile.
- Entrez la forme de la pièce, le jeu et la projection de l'outil.

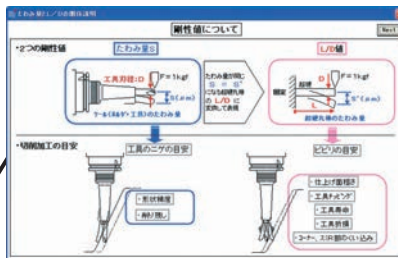

Optimum holder is listed.

- Der optimale Halter ist aufgeführt.
- È elencato il portautensili ottimale.
- Le porte-outils optimal est listé.

Below CAM simulators have all of SLIMLINE geometry datas.

Alle unten angegebenen CAM-Simulatoren sind mit sämtlichen geometrischen SLIMLINE-Daten ausgestattet.

I simulatori sotto CAM presentano tutti i dati geometrici di SLIMLINE.

Les simulateurs FAO ci-dessous ont toutes les données géométriques SLIMLINE.

CAM-TOOL	edgcam	worknc	hyperMILL[®] AXIS	CAD/CAM Solution Company JBM	GENETEC	SIEMENS
CAM-TOOL	EDGECAM	WORK NC	HYPER MILL	JBM	GENETEC	Siemens PLM Software
FF/cam	tebis	Delcam PowerMILL	CADmeister	VISI	VERICUT[®]	
FF/cam	TEBIS	PowerMill	CAD meister	VISI	VERICUT	



Handling methods vary depending on shape data. Contact each manufacturer.

- Die Handabungsverfahren richten sich nach den Konturdaten. Wenden Sie sich bitte an den jeweiligen Hersteller.
- I metodi di impiego variano in base ai dati della forma. Contattare ciascun produttore.
- Les méthodes de manipulation varient en fonction des données de forme. Contactez les fabricants.

Dimensions BT30

Deflection value
($\mu\text{m}/\text{kgf}$)



BT30 – SLSA10-90 cv

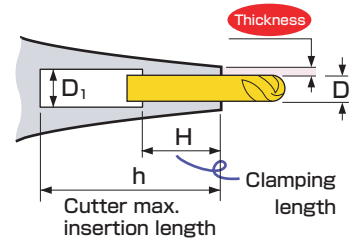
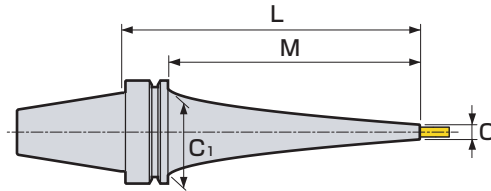

Scale model	CODE	ϕD	ϕC	Thick-ness	L	M	ϕC_1	ϕD_1	H	h	Kg	N	S
1	BT30-SLSA 4- 75 cv	4	7	1.5	75	53	34	5	12	99	0.5	1.0	1.8
2	- 90 cv				90	68				114		1.1	2.8
3	-120 cv				120	98				144		1.2	6.6
4	-SLRA 4- 90 cv	4	10	3	90	68	34	5	12	114	0.5	1.0	2.0
5	-120 cv				120	98				144		1.1	2.9
6	-SLSA 6- 75 cv	6	9	1.5	75	53	34	7	18	99	0.5	1.3	1.5
7	- 90 cv				90	68				114		1.0	2.4
8	-120 cv				120	98				144		1.2	5.6
9	-SLRA 6- 90 cv	6	13	3.5	90	68	34	7	18	114	0.5	1.1	1.6
10	-120 cv				120	98				144		1.2	2.5
11	-SLSA 8- 75 cv	8	11	1.5	75	53	34	9	24	99	0.5	1.1	1.3
12	- 90 cv				90	68				114	0.6	1.6	2.2
13	-SLRA 8- 90 cv	8	16	4	90	68	34	9	24	114	0.5	1.2	1.1
14	-SLSA10- 75 cv	10	13	1.5	75	53	34	11	30	99	0.5	1.6	1.2
15	- 90 cv				90	68				114		1.4	2.0
16	-SLRA10- 90 cv	10	19	4.5	90	68	34	11	30	114	0.6	1.5	1.1

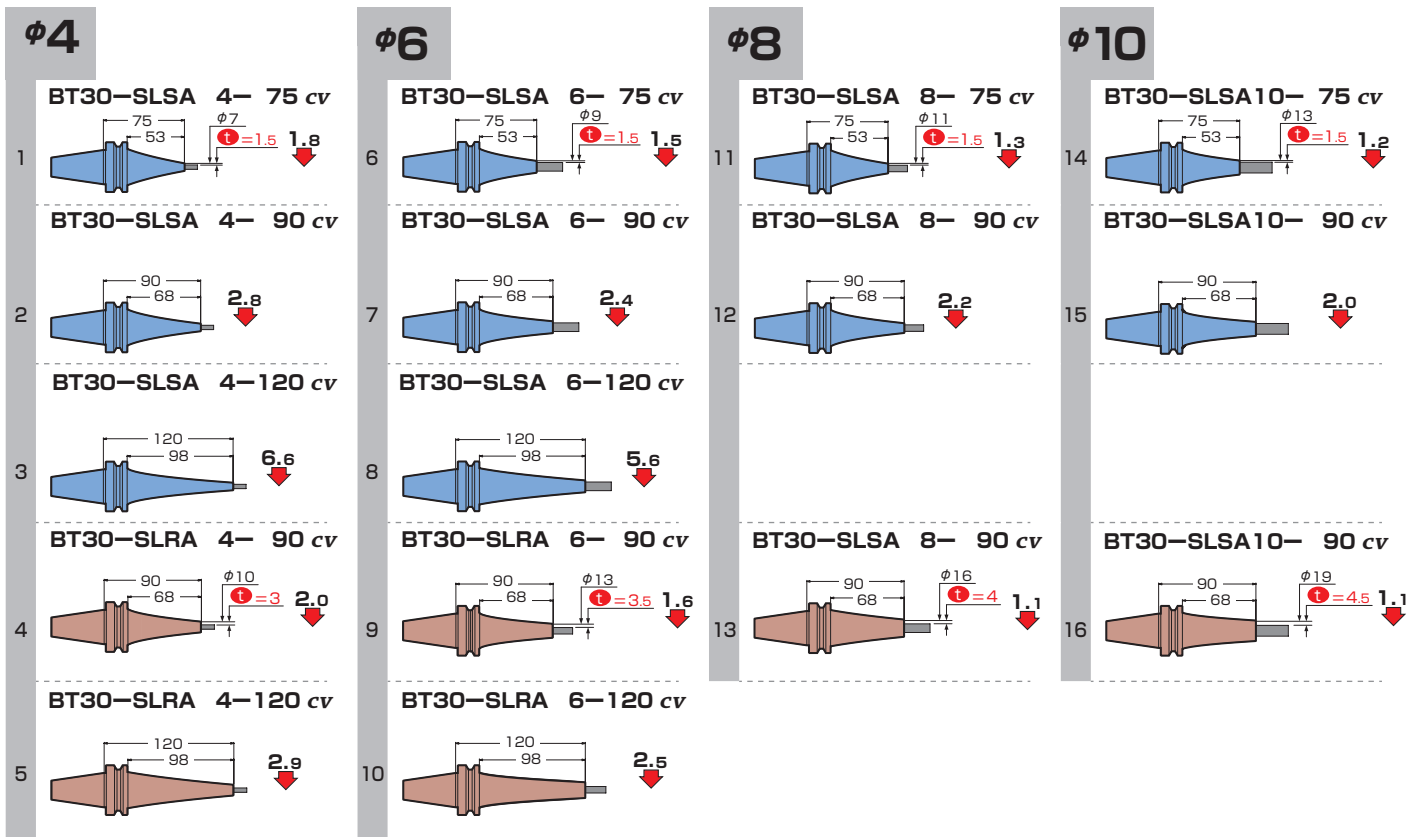

Dimensions BT40

Deflection value
($\mu\text{m}/\text{kgf}$)



BT40-SLSA6-150 cv

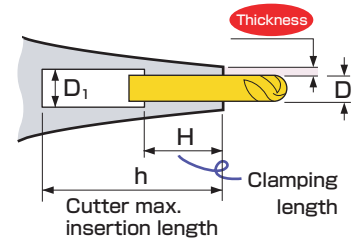
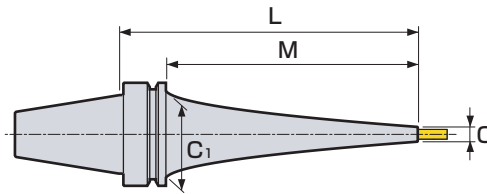

Scale model	CODE	ϕD	ϕC	Thick-ness	L	M	ϕC_1	ϕD_1	H	h	Kg	N	S
1	BT40-SLSA 4- 90 cv	4	7	1.5	90	63	53	5	12	125	1.2	3.3	1.8
2	-120 cv				120	93				155	1.3	3.8	2.7
3	-150 cv				150	123				185	1.5	4.4	4.0
4	-180 cv				180	153				215	1.6	4.8	6.6
5	-210 cv				210	183				245		4.9	11.6
6	-240 cv				240	213				275	1.8	5.8	14.0
7	-SLRA 4-120 cv	4	10	3	120	93	53	5	12	155	1.3	3.9	1.9
8	-150 cv				150	123				185	1.4	4.3	2.9
9	-180 cv				180	153				215	1.5	5.1	4.2
10	-210 cv				210	183				245	1.7	5.7	5.7
11	-SLSA 6- 90 cv	6	9	1.5	90	63	53	7	18	125	1.2	3.3	1.6
12	-120 cv				120	93				155	1.3	3.8	2.3
13	-150 cv				150	123				185	1.5	4.3	3.6
14	-180 cv				180	153				215	1.7	4.9	5.7
15	-210 cv				210	183				245		5.7	7.3
16	-240 cv				240	213				275	1.8	5.9	12.0
17	-SLRA 6- 90 cv	6	13	3.5	90	63	53	7	18	125	1.2	3.3	1.2
18	-120 cv				120	93				155	1.3	4.0	1.7
19	-150 cv				150	123				185	1.5	4.8	2.1
20	-180 cv				180	153				215	1.7	5.6	2.8
21	-210 cv				210	183				245		5.9	4.8
22	-SLFA 6- 90 cv	6	13	3.5	90	63	53	7	18	125	1.2	3.3	1.2
23	-120 cv				120	93				155	1.3	4.0	1.7
24	-150 cv				150	123				185	1.5	4.8	2.1
25	-180 cv				180	153				215	1.7	5.6	2.8
26	-210 cv				210	183				245		5.9	4.8
27	-SLSA 8- 90 cv				8	11				1.5	90	63	53
28	-120 cv	120	93	155			1.3	4.0	2.0				
29	-150 cv	150	123	185			1.5	4.8	2.7				
30	-180 cv	180	153	215			1.6	4.9	5.0				
31	-210 cv	210	183	245				1.7	5.8		6.6		
32	-240 cv	240	213	275			1.9	6.7	8.3				
33	-SLRA 8- 90 cv	8	16	4	90	63	53	9	24	125	1.2	3.8	0.7
34	-120 cv				120	93				155	1.4	4.2	1.2
35	-150 cv				150	123				185	1.6	4.9	1.8
36	-180 cv				180	153				215	1.7	5.7	2.6
37	-210 cv				210	183				245		1.8	6.5
38	-SLFA 8- 90 cv	8	16	4	90	63	53	9	24	125	1.2	3.8	0.7
39	-120 cv				120	93				155	1.4	4.2	1.2
40	-150 cv				150	123				185	1.6	4.9	1.8
41	-180 cv				180	153				215	1.7	5.7	2.6
42	-210 cv				210	183				245		1.8	6.5

Scale model	CODE	ϕD	ϕC	Thick-ness	L	M	ϕC_1	ϕD_1	H	h	Kg	N	S
43	BT40-SLSA10- 90 cv	10	13	1.5	90	63	53	11	30	125	1.2	3.3	1.8
44	-120 cv				120	93				155	1.5	4.3	1.3
45	-150 cv				150	123				185	1.6	4.9	2.2
46	-180 cv				180	153				215	1.7	5.6	3.4
47	-210 cv				210	183				245		6.0	6.0
48	-240 cv				240	213				275	2.0	7.9	5.8
49	-SLRA10- 90 cv	10	19	4.5	90	63	53	11	30	125	1.3	3.8	0.7
50	-120 cv				120	93				155	1.4	4.6	0.9
51	-150 cv				150	123				185	1.6	5.4	1.4
52	-180 cv				180	153				215	1.8	6.3	2.0
53	-210 cv				210	183				245		7.2	3.1
54	-SLFA10- 90 cv	10	19	4.5	90	63	53	11	30	125	1.3	3.8	0.7
55	-120 cv				120	93				155	1.4	4.6	0.9
56	-150 cv				150	123				185	1.6	5.4	1.4
57	-180 cv				180	153				215	1.8	6.3	2.0
58	-210 cv				210	183				245		7.2	3.1
59	-SLSA12- 90 cv	12	15	1.5	90	63	53	14	30	125	1.3	3.7	1.5
60	-120 cv				120	93		13		155	1.5	4.6	1.2
61	-150 cv				150	123				185		4.9	2.4
62	-180 cv				180	153				215	1.7	5.7	3.3
63	-210 cv				210	183				245	1.9	6.6	4.6
64	-240 cv				240	213				275	2.0	8.0	5.5
65	-SLRA12- 90 cv	12	22	5	90	63	53	14	30	125	1.3	3.9	0.6
66	-120 cv				120	93				155	1.6	5.1	0.7
67	-150 cv				150	123		13		185	1.7	6.0	1.1
68	-180 cv				180	153				215		6.9	1.9
69	-210 cv				210	183				245	1.8	7.7	2.8
70	-SLFA12- 90 cv	12	22	5	90	63	53	14	30	125	1.3	3.9	0.6
71	-120 cv				120	93				155	1.6	5.1	0.7
72	-150 cv				150	123		13		185	1.7	6.0	1.1
73	-180 cv				180	153				215		6.9	1.9
74	-210 cv				210	183				245	1.8	7.7	2.8
75	-SLSB16- 90 cv	16	21	2.5	90	63	53	17	32	100	1.3	4.2	0.6
76	-120 cv				120	93				130	1.5	5.5	0.8
77	-150 cv				150	123				160	1.6	6.2	1.5
78	-180 cv				180	153				190	1.9	7.5	1.9
79	-210 cv				210	183				220	2.0	8.2	3.0
80	-240 cv				240	213				250	2.2	9.5	3.7
81	-SLSB20- 90 cv	20	26	3	90	63	50.5	21	40	100	1.3	4.4	0.5
82	-120 cv				120	93	53			130	1.5	5.8	0.8
83	-150 cv				150	123				160	1.6	6.7	1.3
84	-180 cv				180	153				190	1.9	8.0	1.8
85	-210 cv				210	183				220	2.1	9.4	2.3
86	-240 cv				240	213				250	2.4	10.7	3.0

For SLIMLINE MONO CURVE customers.

Please note that we changed model number for SLIMLINE MONO CURVE due to additional model lineup.

Example; Previous model no. : **A63-SLSC6-120**

New model no. : **A63-SLSA6-120 CV**

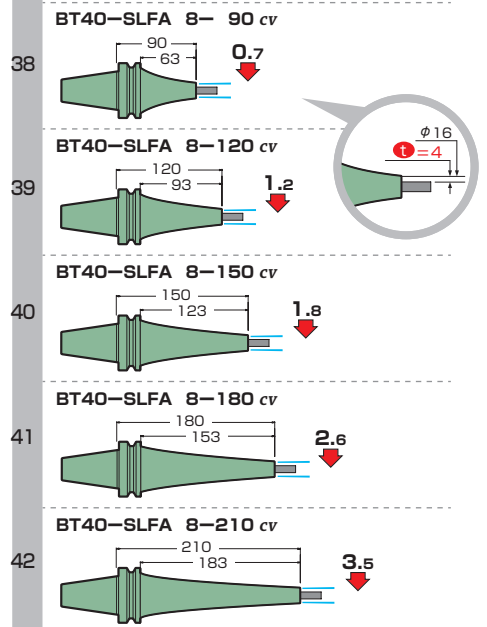
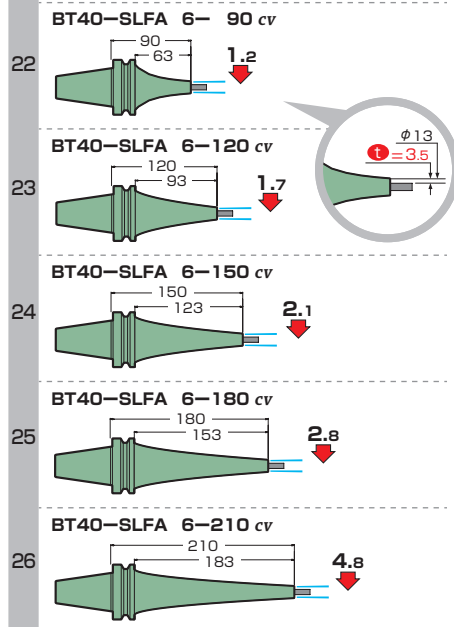
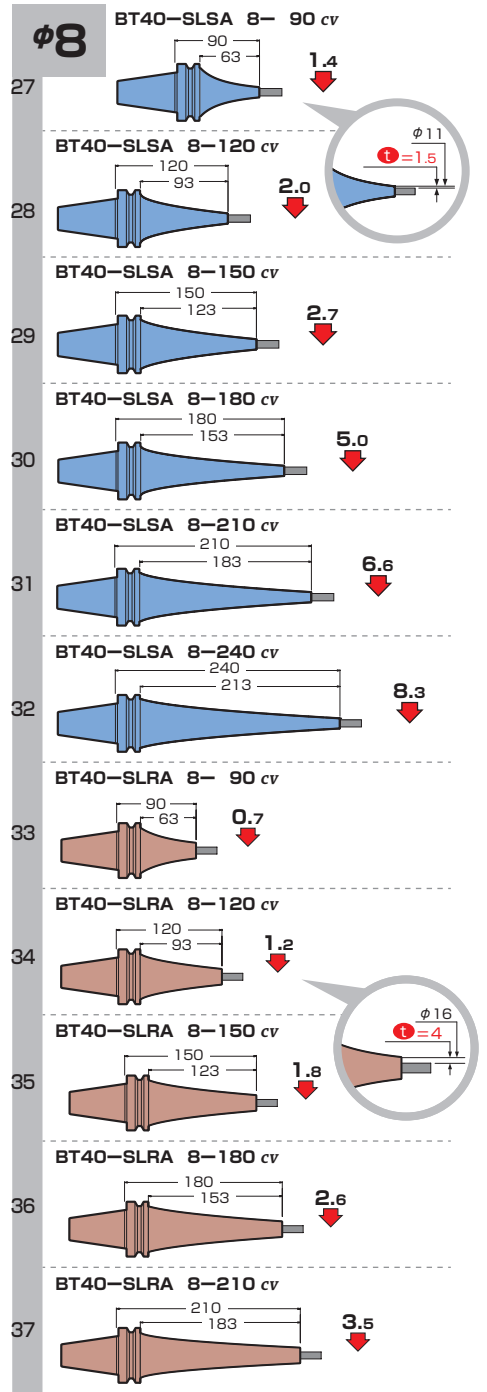
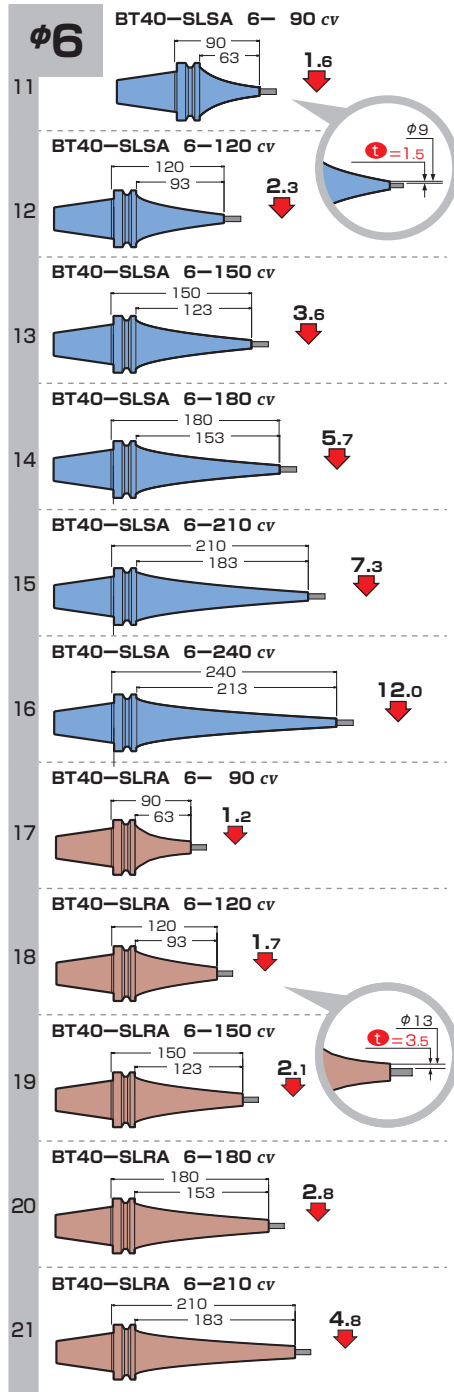
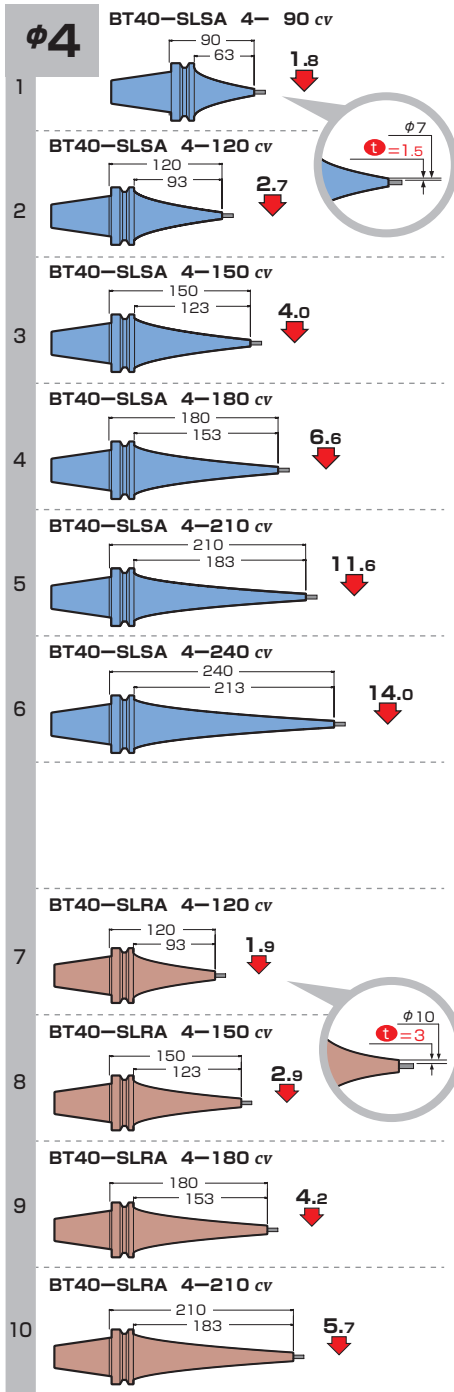

BT40

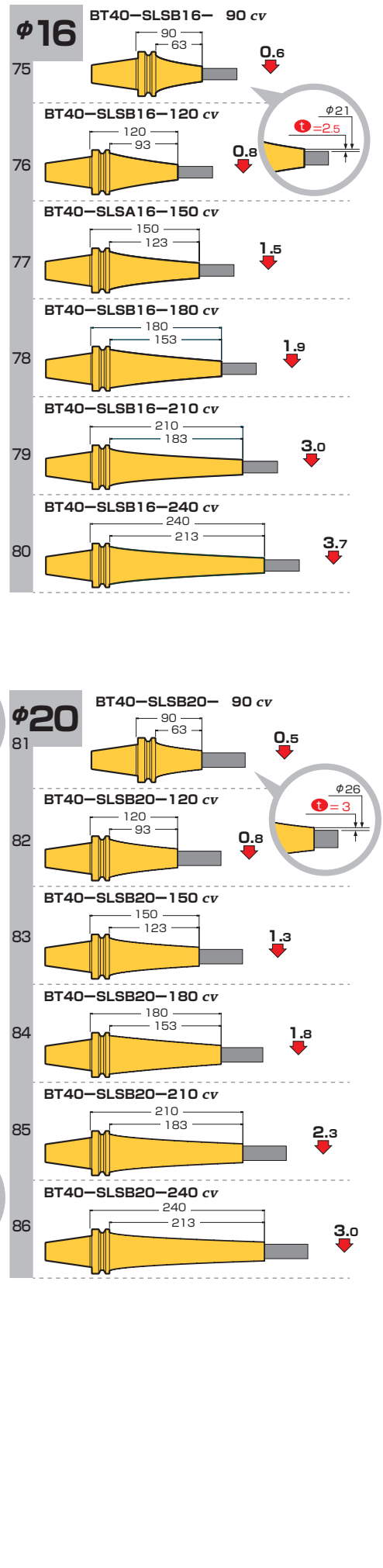
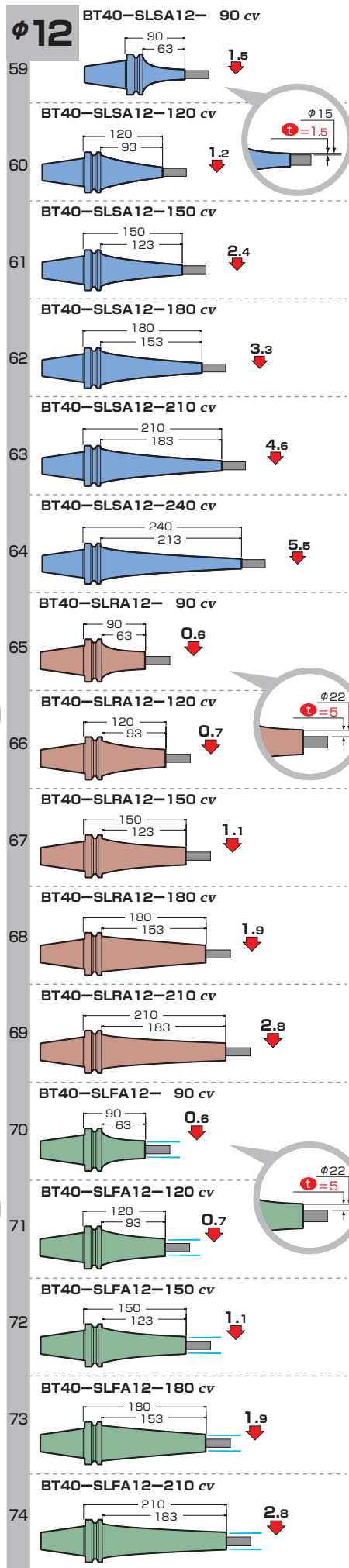
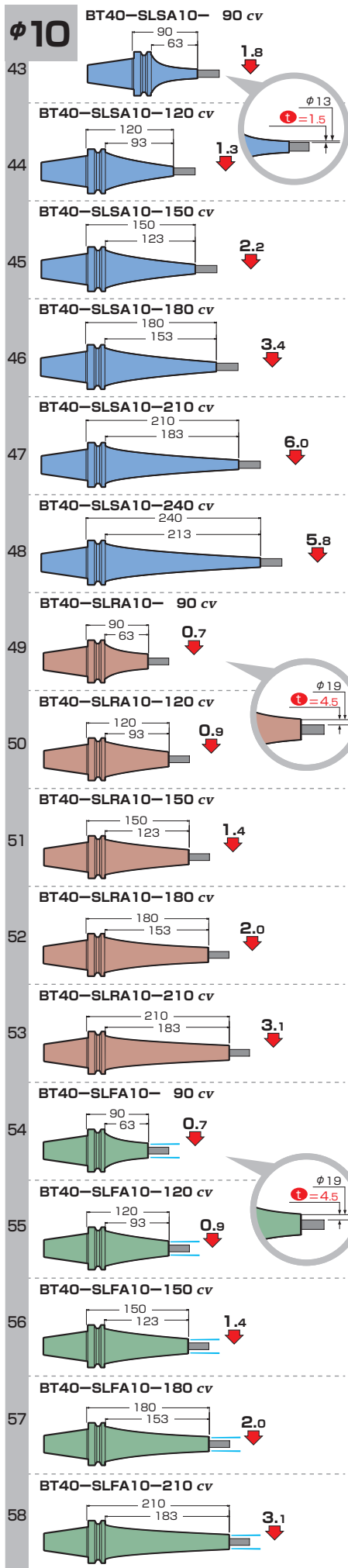

Dimensions
BT50



Deflection value
($\mu\text{m}/\text{kgf}$)

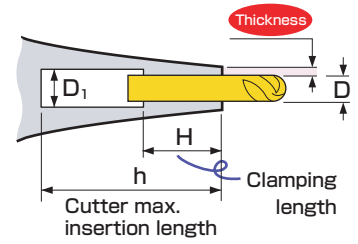
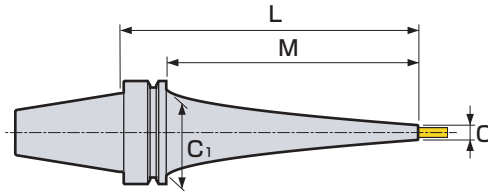

BT50-SLSA6-225 cv



Scale model	CODE	ϕD	ϕC	Thick-ness	L	M	ϕC_1	ϕD_1	H	h	Kg	N	S
1	BT50-SLSA 4-165 cv	4	7	1.5	165	127	85	5	12	220	5.2	15.4	1.8
2	-195 cv				195	157				250	5.3	15.9	2.6
3	-225 cv				225	187				280	5.5	16.4	3.8
4	-255 cv				255	217				310	5.6	16.9	5.7
5	-285 cv				285	247				340	6.4	19.5	5.9
6	-315 cv				315	277				370	8.3	26.0	7.7
7	-SLSA 6-165 cv	6	9	1.5	165	127	85	7	18	220	5.1	15.1	1.5
8	-195 cv				195	157				250	5.2	15.5	2.4
9	-225 cv				225	187				280	5.7	16.8	2.9
10	-255 cv				255	217				310	5.9	18.4	4.0
11	-285 cv				285	247				340	6.2	19.5	5.2
12	-315 cv				315	277				370	8.4	26.8	6.9
13	-SLSA 8-165 cv	8	11	1.5	165	127	85	9	24	220	4.9	14.7	1.4
14	-195 cv				195	157				250	5.3	16.1	1.9
15	-225 cv				225	187				280	5.8	17.7	2.3
16	-255 cv				255	217				310		17.9	3.7
17	-285 cv				285	247				340	6.0	19.1	4.9
18	-315 cv				315	277				370	8.4	28.0	5.0
19	-SLRA 8-195 cv	8	16	4	195	157	85	9	24	250	5.4	17.3	1.1
20	-225 cv				225	187				280	5.6	18.3	1.5
21	-255 cv				255	217				310	5.8	19.1	2.2
22	-285 cv				285	247				340	5.9	19.9	3.0
23	-SLFA 8-195 cv	8	16	4	195	157	85	9	24	250	5.4	17.3	1.1
24	-225 cv				225	187				280	5.6	18.3	1.5
25	-255 cv				255	217				310	5.8	19.1	2.2
26	-285 cv				285	247				340	5.9	19.9	3.0
27	-SLSA10-165 cv	10	13	1.5	165	127	85	11	30	220	4.9	14.9	1.2
28	-195 cv				195	157				250	5.5	16.9	1.5
29	-225 cv				225	187				280	5.4	16.8	2.4
30	-255 cv				255	217				310	6.1	19.8	2.6
31	-285 cv				285	247				340	6.3	21.2	3.7
32	-315 cv				315	277				370	8.4	28.6	4.6
33	-SLRA10-165 cv	10	19	4.5	165	127	85	11	30	220	5.1	15.9	0.7
34	-195 cv				195	157				250	5.2	16.6	1.1
35	-225 cv				225	187				280	5.9	19.7	1.2
36	-255 cv				255	217				310	6.1	20.3	1.7
37	-285 cv				285	247				340	6.2	21.1	2.4
38	-SLFA10-165 cv	10	19	4.5	165	127	85	11	30	220	5.1	15.9	0.7
39	-195 cv				195	157				250	5.2	16.6	1.1
40	-225 cv				225	187				280	5.9	19.7	1.2
41	-255 cv				255	217				310	6.1	20.3	1.7
42	-285 cv				285	247				340	6.2	21.1	2.4

Scale model	CODE	ϕD	ϕC	Thick-ness	L	M	ϕC_1	ϕD_1	H	h			
43	BT50-SLSA12-165 cv	12	15	1.5	165	127	84	13	30	220	4.8	14.6	1.2
44	-195 cv				195	157	85			250	5.6	17.6	
45	-225 cv				225	187				280	5.8	18.5	1.8
46	-255 cv				255	217				310	6.0	19.3	2.6
47	-285 cv				285	247				340	6.2	21.2	3.5
48	-315 cv				315	277				370	8.5	29.2	3.6
49	BT50-SLRA12-165 cv	12	22	5	165	127	85	14	30	220	5.1	16.1	0.7
50	-195 cv				195	157		13		250	5.6	18.0	0.8
51	-225 cv				225	187				280		18.6	1.3
52	-255 cv				255	217				310	5.8	20.7	1.6
53	-285 cv				285	247				340	6.1	22.4	2.1
54	BT50-SLFA12-165 cv				12	22		5		165	127	85	14
55	-195 cv	195	157	13			250		5.6	18.0	0.8		
56	-225 cv	225	187				280			18.6	1.3		
57	-255 cv	255	217				310		5.8	20.7	1.6		
58	-285 cv	285	247				340		6.1	22.4	2.1		
59	-SLSB16-165 cv	16	21	2.5			165		127	85	17		32
60	-195 cv				195	157	250		17.7			1.1	
61	-225 cv				225	187	280	6.3	21.1			1.2	
62	-255 cv				255	217	310	6.1	20.9			2.0	
63	-285 cv				285	247	340	7.0	24.3				
64	-315 cv				315	277	370	8.6	30.9			2.6	
65	-SLSB20-165 cv	20	26	3	165	127	85	21	40	220	5.4	17.4	0.6
66	-195 cv				195	157				250	6.1	20.8	0.7
67	-225 cv				225	187				280	5.8	20.5	1.2
68	-255 cv				255	217				310	6.7	23.9	1.3
69	-285 cv				285	247				340	7.0	25.4	1.7
70	-315 cv				315	277				370	8.9	32.4	2.3

For SLIMLINE MONO CURVE customers.

Please note that we changed model number for SLIMLINE MONO CURVE due to additional model lineup.

Example; Previous model no. : **A63-SLSC6-120**

New model no. : **A63-SLSA6-120 CV**

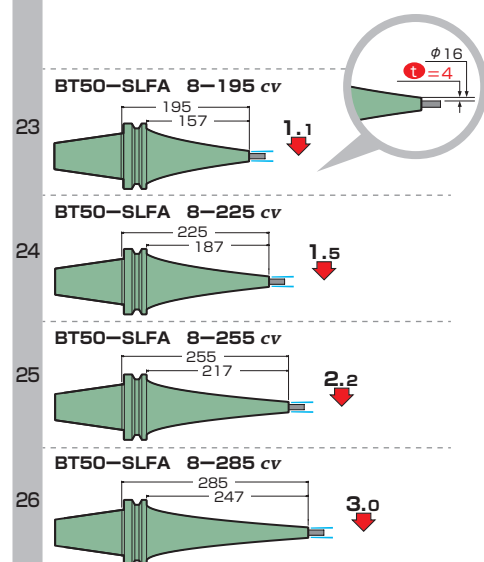
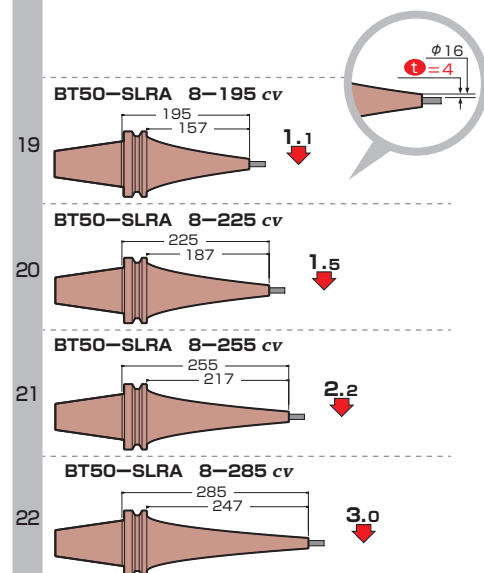
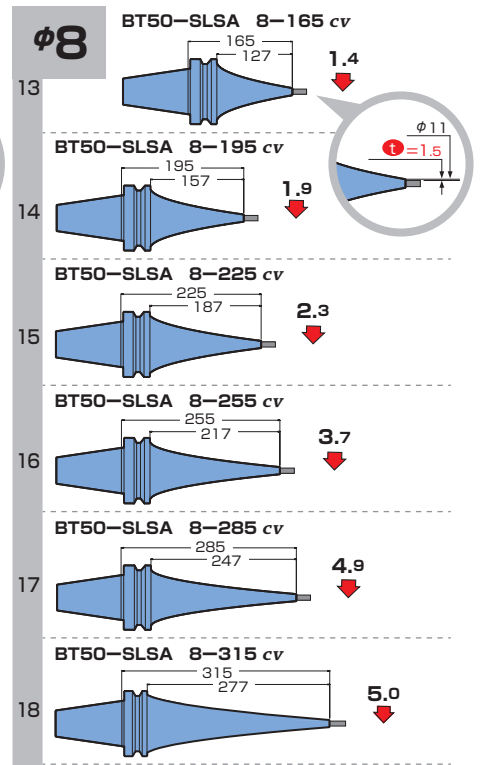
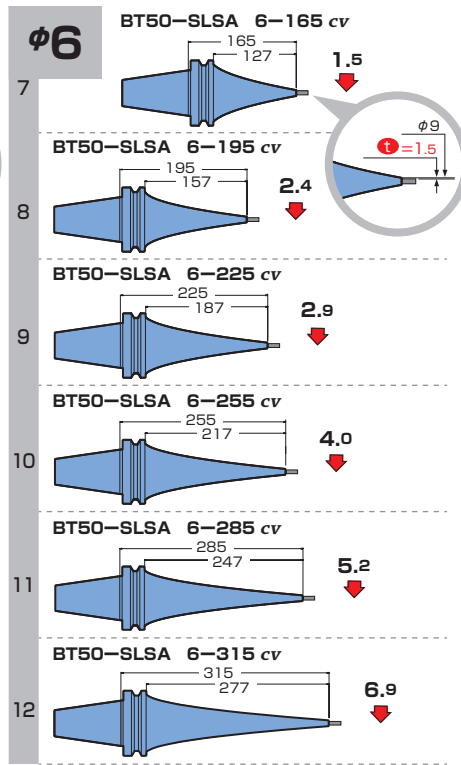
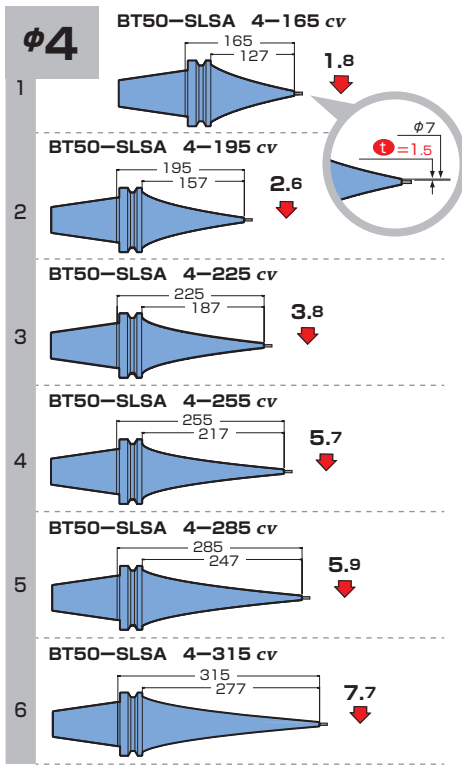

BT50

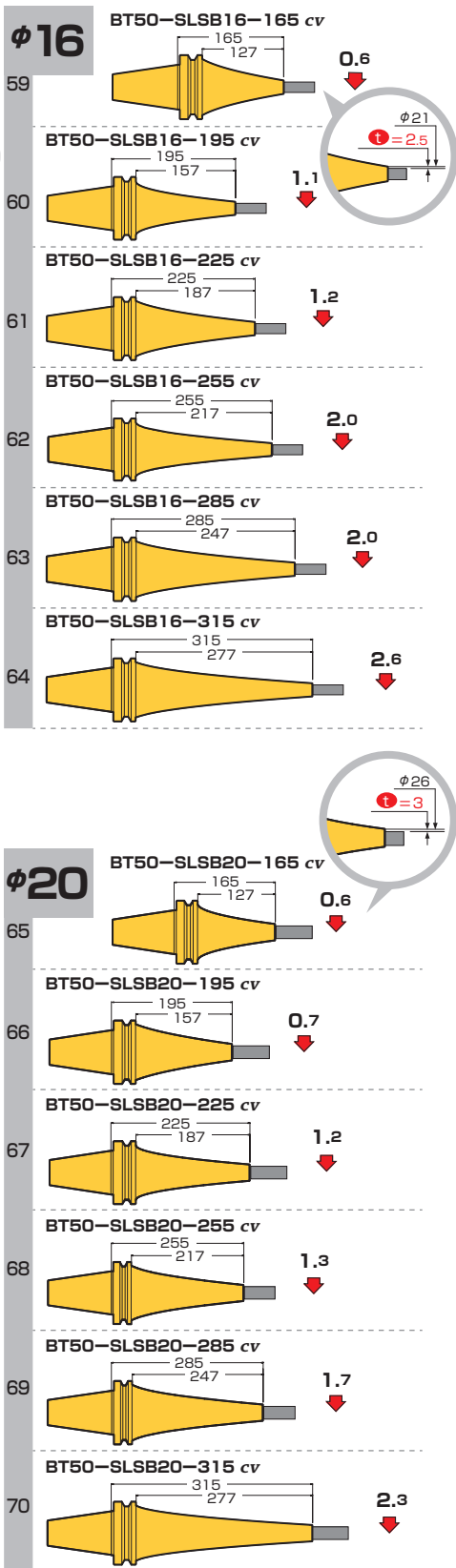
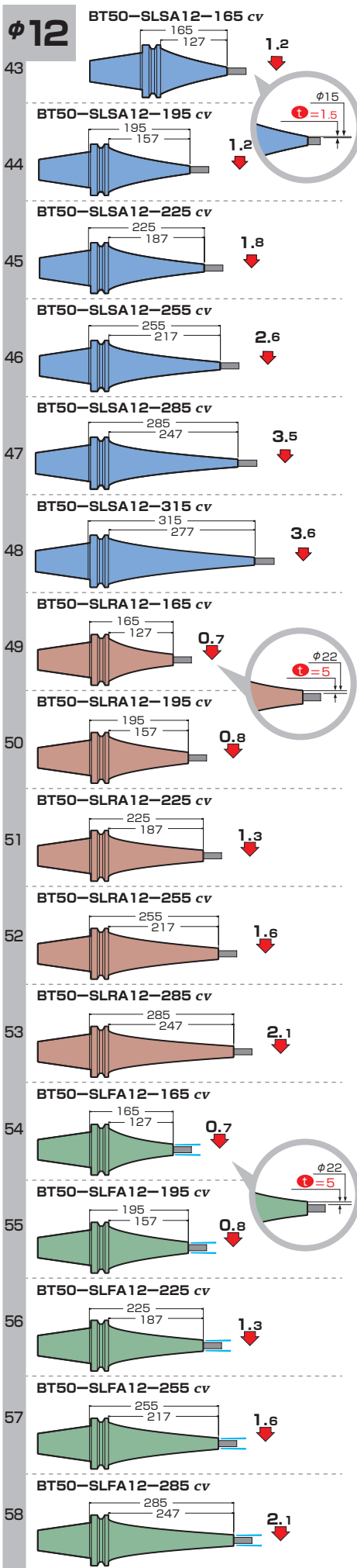
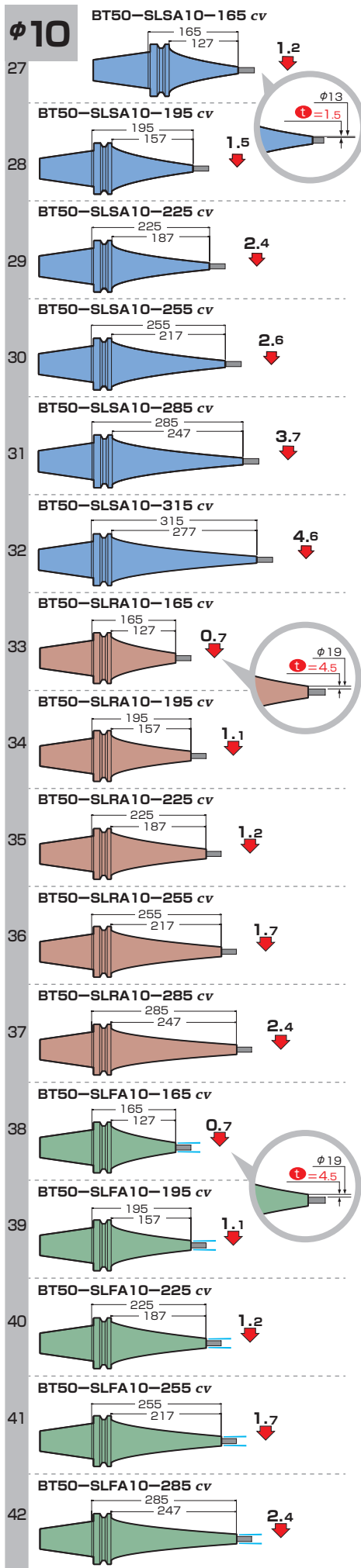

Dimensions
A63

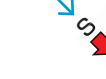

Deflection value
($\mu\text{m}/\text{kgf}$)

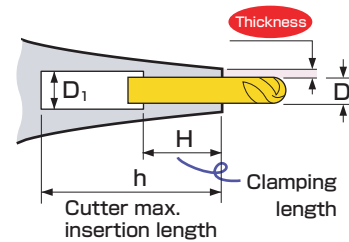
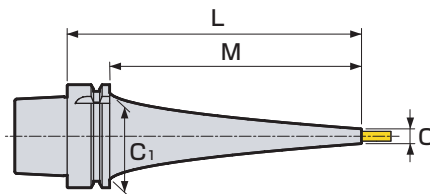

A63-SLRA6-150 cv



Scale model	CODE	ϕD	ϕC	Thick-ness	L	M	ϕC_1	ϕD_1	H	h	Kg	N	S						
1	A63-SLSA 4- 90 cv	4	7	1.5	90	64	53	5	12	65	1.0	9.3	1.8						
2	-120 cv				120	94				95	1.1	10.1	2.7						
3	-150 cv				150	124				125	1.3	11.0	4.0						
4	-180 cv				180	154				154	1.4	11.6	6.6						
5	-210 cv				210	184				185		11.8	11.6						
6	-240 cv				240	214				214	1.6	13.1	14.0						
7	-270 cv				270	244				245	2.0	15.4	11.9						
8	-300 cv				300	274				275	2.1	16.3	15.9						
9	-SLRA 4-120 cv	4	10	3	120	94	53	5	12	95	1.0	8.6	1.9						
10	-150 cv				150	124				125	1.1	9.3	2.9						
11	-180 cv				180	154				155	1.4	10.9	3.3						
12	-210 cv				210	184				185		11.3	5.6						
13	-SLSA 6- 90 cv	6	9	1.5	90	64	53	7	18	65	1.0	9.4	1.6						
14	-120 cv				120	94				95	1.1	10.1	2.3						
15	-150 cv				150	124				125	1.3	11.0	3.6						
16	-180 cv				180	154				154	1.4	11.7	5.7						
17	-210 cv				210	184				184	1.6	13.0	7.3						
18	-240 cv				240	214				214		13.3	12.0						
19	-270 cv				270	244				245	2.1	16.3	8.5						
20	-300 cv				300	274				275	2.3	17.2	11.7						
21	-SLRA 6- 90 cv				6	13				3.5	90	64	53	7	18	65	1.0	8.3	0.8
22	-120 cv										120	94				95	1.1	9.3	1.2
23	-150 cv	150	124	125			1.3	10.1	1.9										
24	-180 cv	180	154	155			1.4	11.1	2.8										
25	-210 cv	210	184	185				11.5	4.8										
26	-SLFA 6- 90 cv	6	13	3.5	90	64	53	7	18	65	1.0	8.3	0.8						
27	-120 cv				120	94				95	1.1	9.3	1.2						
28	-150 cv				150	124				125	1.3	10.1	1.9						
29	-180 cv				180	154				155	1.4	11.1	2.8						
30	-210 cv				210	184				185		11.5	4.8						
31	-SLSA 8- 90 cv	8	11	1.5	90	64	53	9	24	65	1.0	9.4	1.4						
32	-120 cv				120	94				94	1.1	10.3	2.0						
33	-150 cv				150	124				124	1.3	11.5	2.7						
34	-180 cv				180	154				155	1.4	11.8	5.0						
35	-210 cv				210	184				184	1.6	13.2	6.6						
36	-240 cv				240	214				214	1.8	14.4	8.3						
37	-270 cv				270	244				244	2.2	17.2	6.9						
38	-300 cv				300	274				274	2.4	18.5	8.9						
39	-SLRA 8- 90 cv	8	16	4	90	64	53	9	24	65	1.0	8.4	0.7						
40	-120 cv				120	94				95	1.2	9.6	1.0						
41	-150 cv				150	124				125	1.4	10.8	1.4						
42	-180 cv				180	154				155	1.5	12.0	2.0						
43	-210 cv				210	184				185	1.6	12.5	3.5						
44	-SLFA 8- 90 cv	8	16	4	90	64	53	9	24	65	1.0	8.4	0.7						
45	-120 cv				120	94				95	1.2	9.6	1.0						
46	-150 cv				150	124				125	1.4	10.8	1.4						
47	-180 cv				180	154				155	1.5	12.0	2.0						
48	-210 cv				210	184				185	1.6	12.5	3.5						

Scale model	CODE	ϕD	ϕC	Thick-ness	L	M	ϕC_1	ϕD_1	H	h				
49	A63-SLSA10- 90 cv	10	13	1.5	90	64	53	11	30	65	1.0	9.4	1.3	
50	-120 cv				120	94				95	1.3	10.9		
51	-150 cv				150	124				125	1.4	11.8	2.2	
52	-180 cv				180	154				154	1.6	12.9	3.4	
53	-210 cv				210	184				184		13.3	6.0	
54	-240 cv				240	214				212	2.1	16.0	5.8	
55	-270 cv				270	244				244		17.5	6.6	
56	-300 cv				300	274				274	2.3	18.7	8.6	
57	-SLRA10- 90 cv	10	19	4.5	90	64	53	11	30	65	1.0	8.5	0.6	
58	-120 cv				120	94				95	1.2	9.6	0.9	
59	-150 cv				150	124				125	1.3	10.9	1.4	
60	-180 cv				180	154				155	1.5	12.1	2.0	
61	-210 cv				210	184				185	1.6	13.3	3.1	
62	-SLFA10- 90 cv				90	64				53	11	30	65	1.0
63	-120 cv	120	94	95	1.2	9.6	0.9							
64	-150 cv	150	124	125	1.3	10.9	1.4							
65	-180 cv	180	154	155	1.5	12.1	2.0							
66	-210 cv	210	184	185	1.6	13.3	3.1							
67	-SLSA12- 90 cv	12	15	1.5	90	64	53	14	30	64	1.1	9.9	0.9	
68	-120 cv				120	94		13		94	1.3	11.3	1.2	
69	-150 cv				150	124		124		1.4	11.8	2.4		
70	-180 cv				180	154		154		1.6	13.0	3.3		
71	-210 cv				210	184		184		1.8	14.3	4.6		
72	-240 cv				240	214		212		2.1	16.2	5.5		
73	-270 cv				270	244		244		2.3	18.4	5.4		
74	-SLRA12- 90 cv				12	22		5		90	64	53	14	30
75	-120 cv	120	94	94			1.3		10.4	0.7				
76	-150 cv	150	124	13			124		1.5	11.7	1.1			
77	-180 cv	180	154	154					12.8	1.8				
78	-210 cv	210	184	184			1.6		14.0	2.8				
79	-SLFA12- 90 cv	90	64	53			14		30	64	1.0		8.5	
80	-120 cv	120	94	94	1.3	10.4	0.7							
81	-150 cv	150	124	13	124	1.5	11.7	1.1						
82	-180 cv	180	154	154		12.8	1.8							
83	-210 cv	210	184	184	1.6	14.0	2.8							
84	-SLSB16- 90 cv	16	21	2.5	90	64	53	17	32	62	1.1	10.5	0.6	
85	-120 cv				120	94				92	1.5	12.4	0.8	
86	-150 cv				150	124				122	1.6	13.5	1.5	
87	-180 cv				180	154				152	1.9	15.4	1.9	
88	-210 cv				210	184				182	2.1	16.5	3.0	
89	-240 cv				240	214				212	2.4	18.4	3.7	
90	-270 cv				270	244				242	2.7	20.3	4.6	
91	-SLSB20- 90 cv				20	26				3	90	64	51	21
92	-120 cv	120	94	53			92	1.5	12.8		0.8			
93	-150 cv	150	124	122			1.7	14.1	1.3					
94	-180 cv	180	154	152			2.0	16.2	1.8					
95	-210 cv	210	184	182			2.4	18.2	2.3					
96	-240 cv	240	214	212			2.7	20.2	3.0					
97	-270 cv	270	244	242			3.1	22.8	3.4					

For SLIMLINE MONO CURVE customers.

Please note that we changed model number for SLIMLINE MONO CURVE due to additional model lineup.

Example; Previous model no. : **A63-SLSC6-120**

New model no. : **A63-SLSA6-120 CV**

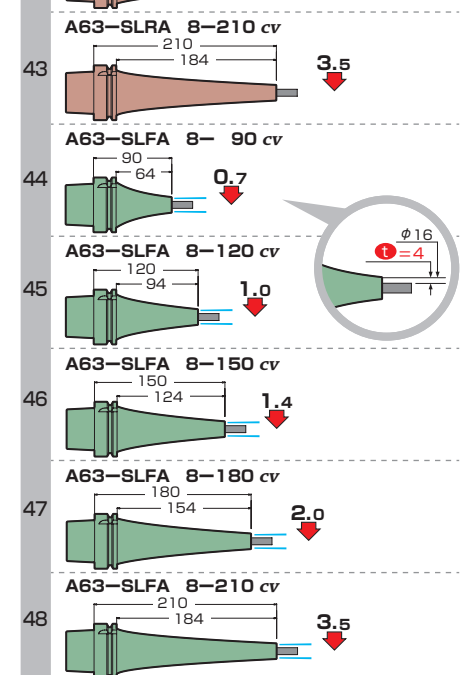
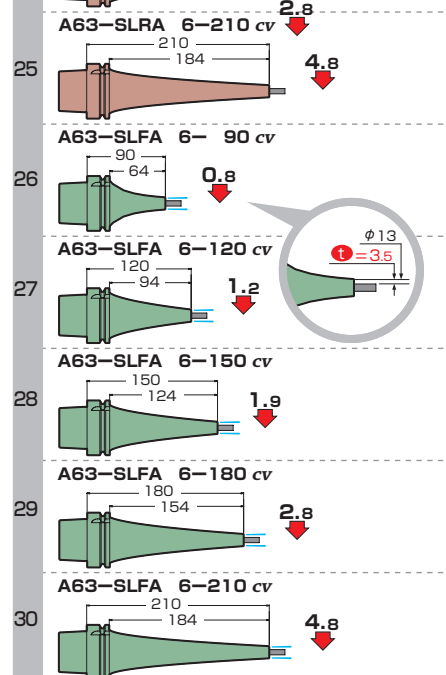
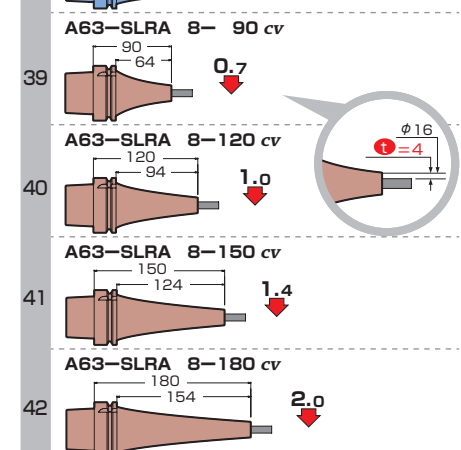
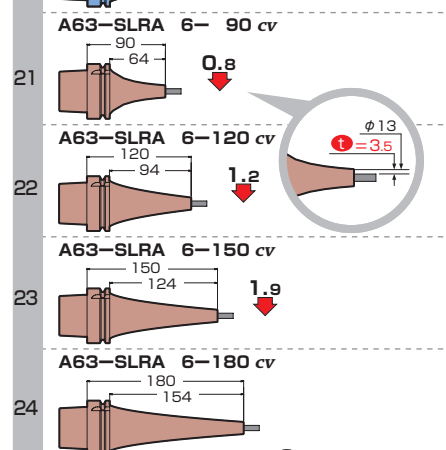
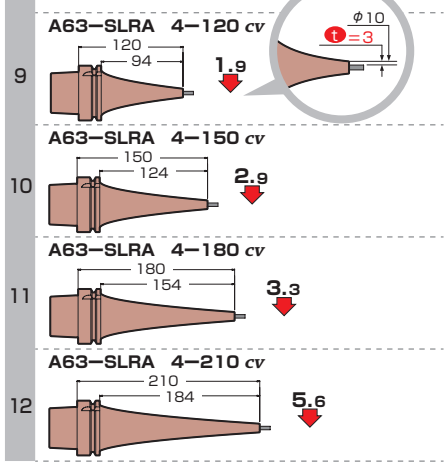
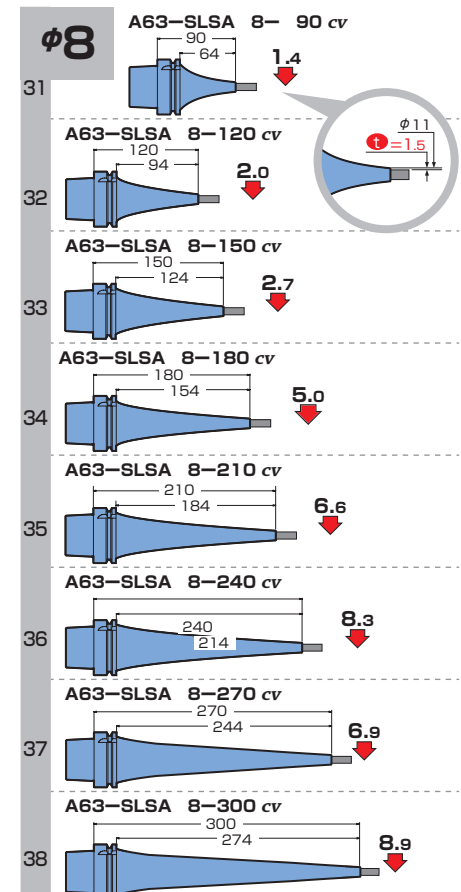
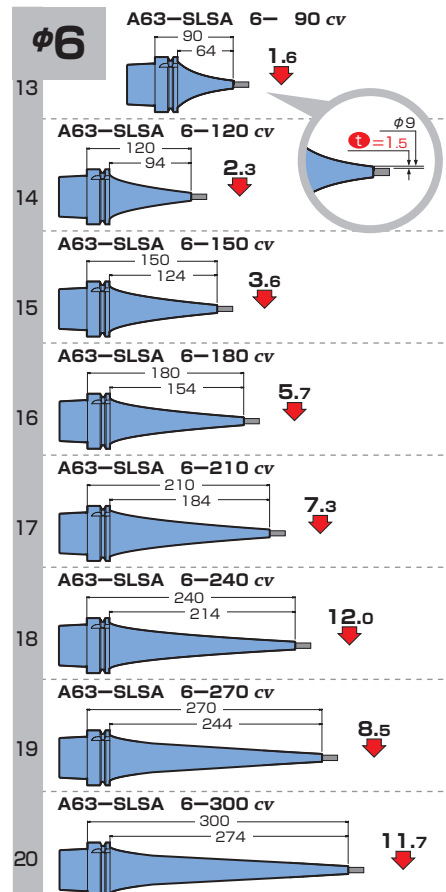
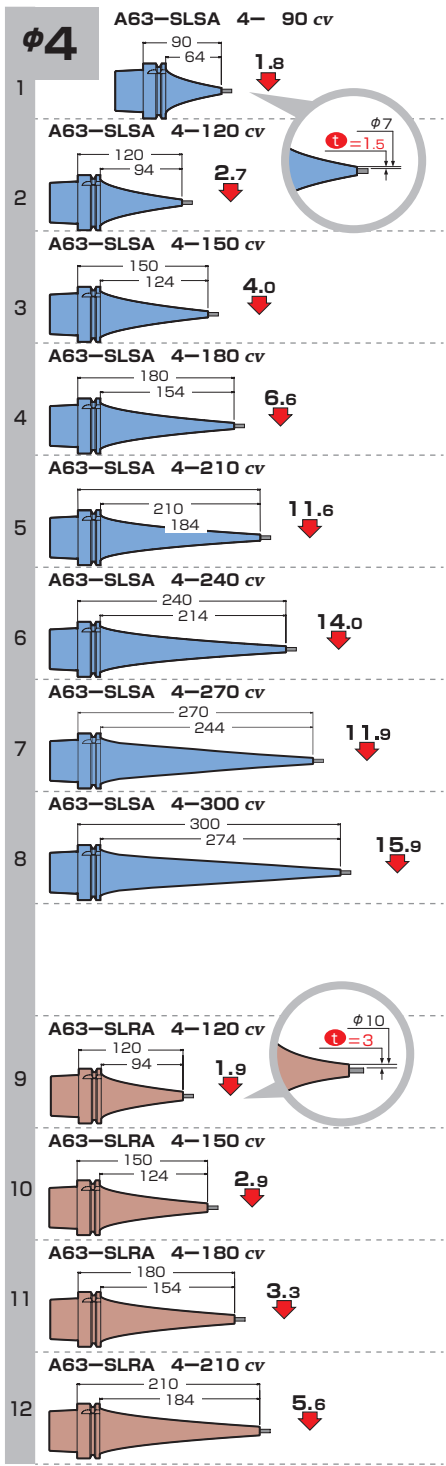

A63

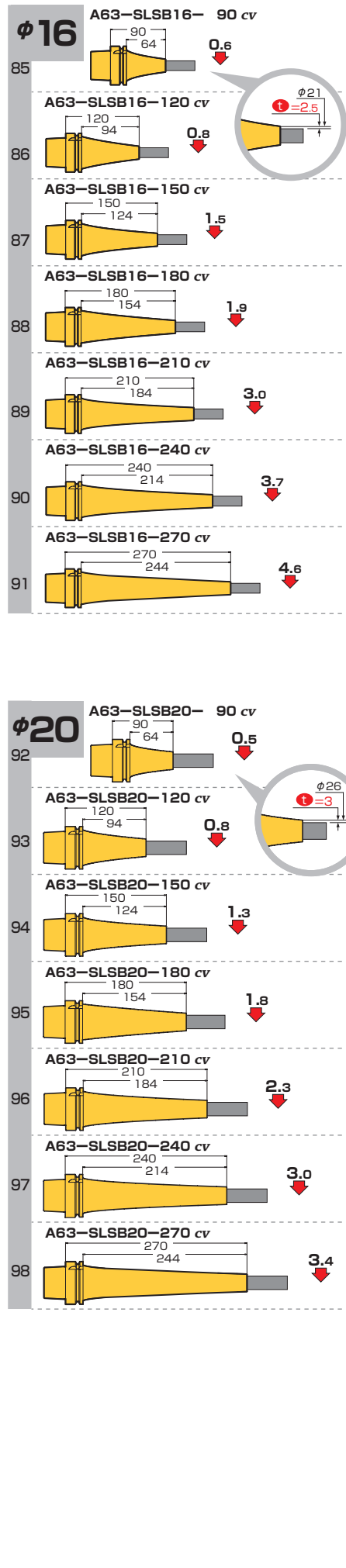
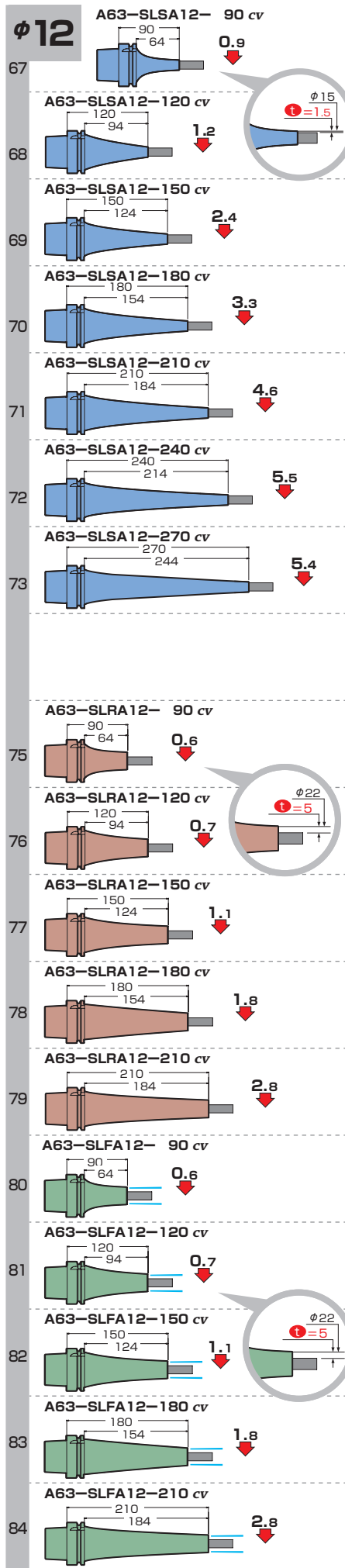
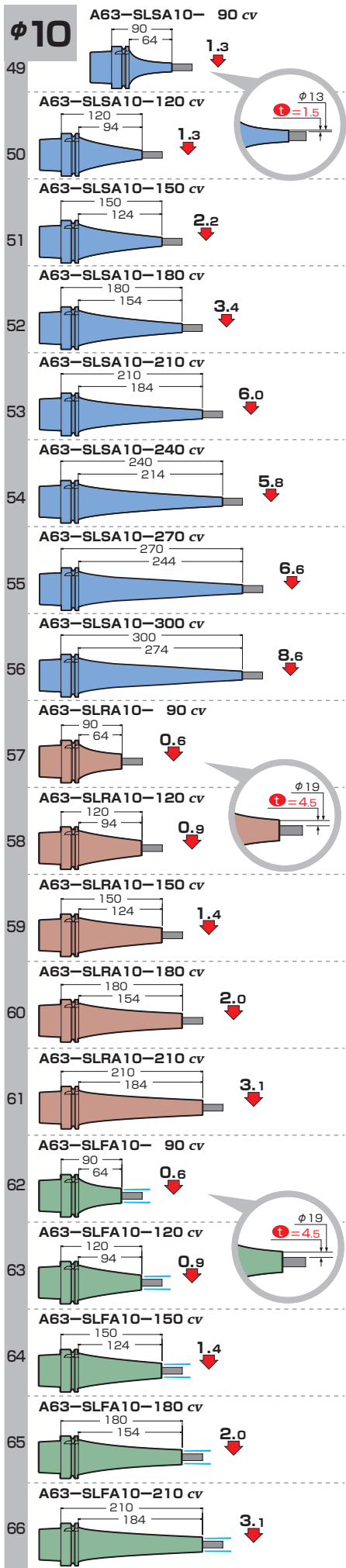

Dimensions A100



Deflection value
($\mu\text{m}/\text{kgf}$)

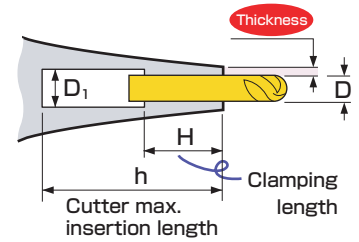
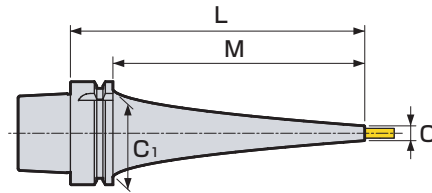

A100-SLSA16-165 cv



Scale model	CODE	ϕD	ϕC	Thick-ness	L	M	ϕC_1	ϕD_1	H	h	Kg	N	S
1	A100-SLSA 4-165 cv	4	7	1.5	165	136	85	5	12	133	3.4	29.0	2.5
2	-195 cv				195	166				163	3.7	30.6	3.3
3	-225 cv				225	196				196	4.3	33.0	3.8
4	-255 cv				255	226				226	4.4	34.1	5.6
5	-285 cv				285	256				256	4.6	35.5	7.6
6	-315 cv				315	286				286	4.9	37.1	9.8
7	-345 cv				345	316				316	5.2	38.8	12.4
8	-SLSA 6-165 cv	6	9	1.5	165	136	85	7	18	136	3.3	28.8	2.1
9	-195 cv				195	166				166	4.0	32.0	2.3
10	-225 cv				225	196				196	4.1	32.4	3.6
11	-255 cv				255	226				226	4.8	35.9	3.9
12	-285 cv				285	256				256	5.0	37.4	5.2
13	-315 cv				315	286				286	5.3	38.9	6.8
14	-345 cv				345	316				316	5.6	40.3	8.7
15	-SLSA 8-165 cv	8	11	1.5	165	136	85	9	24	136	3.7	30.7	1.4
16	-195 cv				195	166				166		31.0	2.3
17	-225 cv				225	196				196	4.6	35.3	
18	-255 cv				255	226				226		35.9	3.6
19	-285 cv				285	256				256	4.9	37.4	4.8
20	-315 cv				315	286				286	5.7	41.9	5.0
21	-345 cv				345	316				311	6.1	45.1	6.0
22	-SLRA 8-195 cv	8	16	4	195	166	85	9	24	166	3.7	28.5	1.4
23	-225 cv				225	196				196	4.4	32.3	1.6
24	-255 cv				255	226				226	4.6	33.6	2.2
25	-285 cv				285	256				256	4.8	34.8	3.0
26	-SLFA 8-195 cv	8	16	4	195	166	85	9	24	166	3.7	28.5	1.4
27	-225 cv				225	196				196	4.4	32.3	1.6
28	-255 cv				255	226				226	4.6	33.6	2.2
29	-285 cv				285	256				256	4.8	34.8	3.0
30	-SLSA10-165 cv	10	13	1.5	165	136	85	11	30	136	3.5	29.4	1.4
31	-195 cv				195	166				166	4.3	33.6	1.5
32	-225 cv				225	196				196	4.2	33.4	2.4
33	-255 cv				255	226				226	4.5	34.3	3.5
34	-285 cv				285	256				251	5.1	38.3	3.6
35	-315 cv				315	286				286		39.9	4.8
36	-345 cv				345	316				311	5.9	42.7	5.5
37	-SLRA10-165 cv	10	19	4.5	165	136	85	11	30	136	3.5	27.6	1.0
38	-195 cv				195	166				166	4.0	30.1	1.1
39	-225 cv				225	196				196	4.1	31.1	1.6
40	-255 cv				255	226				226	4.9	35.3	1.7
41	-285 cv				285	256				256	5.0	36.2	2.4
42	-SLFA10-165 cv	10	19	4.5	165	136	85	11	30	136	3.5	27.6	1.0
43	-195 cv				195	166				166	4.0	30.1	1.1
44	-225 cv				225	196				196	4.1	31.1	1.6
45	-255 cv				255	226				226	4.9	35.3	1.7
46	-285 cv				285	256				256	5.0	36.2	2.4

Scale model	CODE	ϕD	ϕC	Thick-ness	L	M	ϕC_1	ϕD_1	H	h			
47	A100-SLSA12-165 cv	12	15	1.5	165	136	85	13	30	133	4.2	34.1	1.2
48	-195 cv				195	166				163	4.1	33.6	
49	-225 cv				225	196				175	4.8	38.3	1.8
50	-255 cv				255	226				190		37.8	2.6
51	-285 cv				285	256				251	5.5	42.5	3.5
52	-315 cv				315	286				281	5.9	44.6	4.3
53	-345 cv				345	316				311	6.2	46.7	5.3
54	-SLRA12-165 cv	12	22	5	165	136	85	13	30	133	3.6	27.9	0.8
55	-195 cv				195	166		14		163	4.4	32.2	
56	-225 cv				225	196		13		159		32.7	1.3
57	-255 cv				255	226		221		4.6	36.1	1.6	
58	-285 cv				285	256		251		5.0	38.5	2.1	
59	-SLFA12-165 cv				12	22		5		165	136	85	13
60	-195 cv	195	166	14			163		4.4	32.2			
61	-225 cv	225	196	13			159			32.7	1.3		
62	-255 cv	255	226	221			4.6		36.1	1.6			
63	-285 cv	285	256	251			5.0		38.5	2.1			
64	-SLSB16-165 cv	16	21	2.5	165	136	85	17	32	131	4.2	34.2	0.6
65	-195 cv				195	166				161	4.0	33.7	1.1
66	-225 cv				225	196				191	4.8	38.4	1.2
67	-255 cv				255	226				221	4.7	38.0	2.0
68	-285 cv				285	256				251	5.5	42.6	
69	-315 cv				315	286				281	5.9	44.8	2.6
70	-345 cv				345	316				311	6.2	46.9	3.3
71	-SLSB20-165 cv	20	26	3	165	136	85	21	40	132	4.0	33.6	0.6
72	-195 cv				195	166				161	4.9	38.1	0.7
73	-225 cv				225	196				191	4.6	37.4	1.2
74	-255 cv				255	226				221	5.5	42.1	1.3
75	-285 cv				285	256				251	5.2	41.2	2.1
76	-315 cv				315	286				281	6.1	46.0	2.3
77	-345 cv				345	316				311	6.4	47.9	2.9

For SLIMLINE MONO CURVE customers.

Please note that we changed model number for SLIMLINE MONO CURVE due to additional model lineup.

Example; Previous model no. : **A63-SLSC6-120**

New model no. : **A63-SLSA6-120 CV**

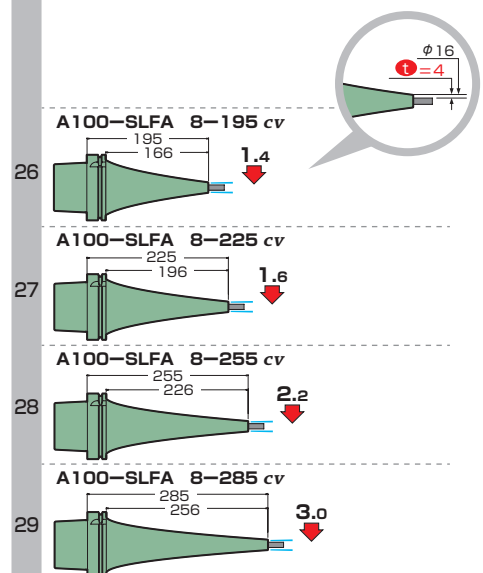
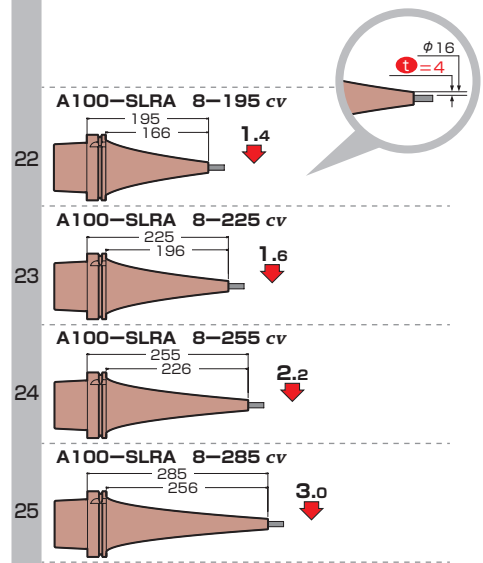
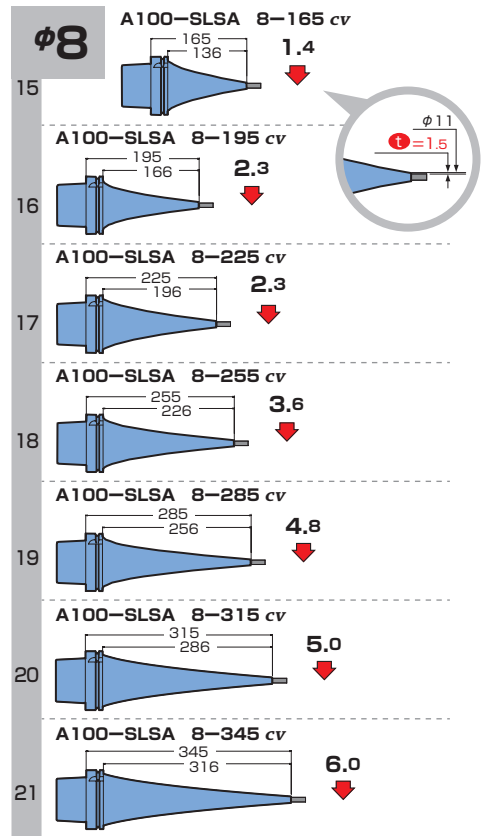
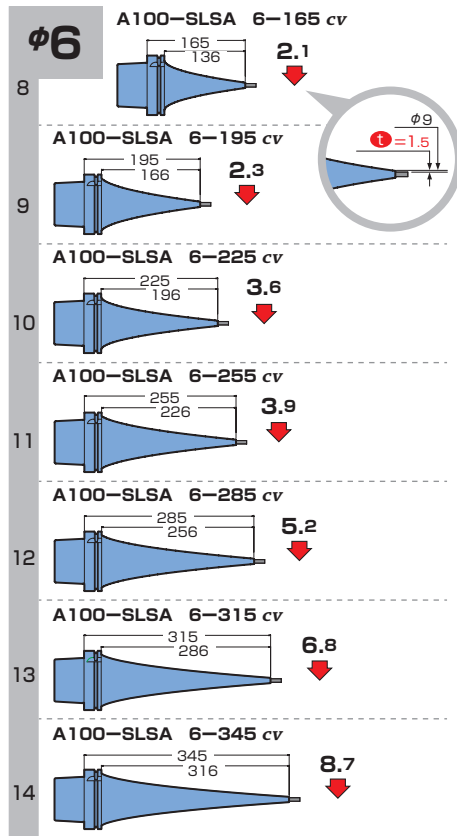
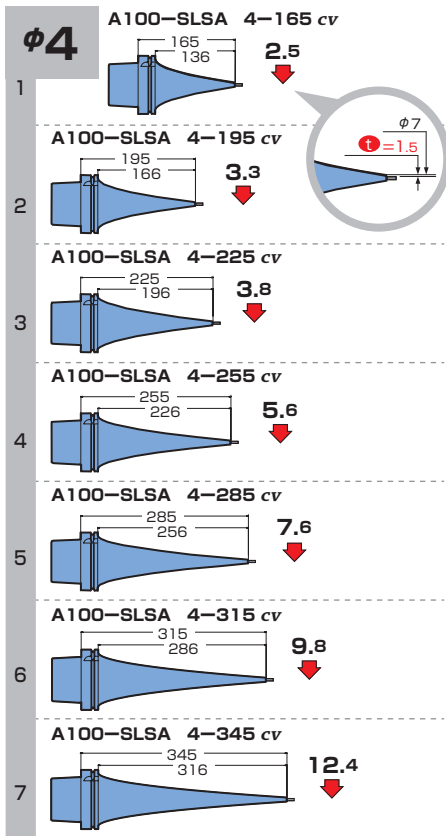

A100

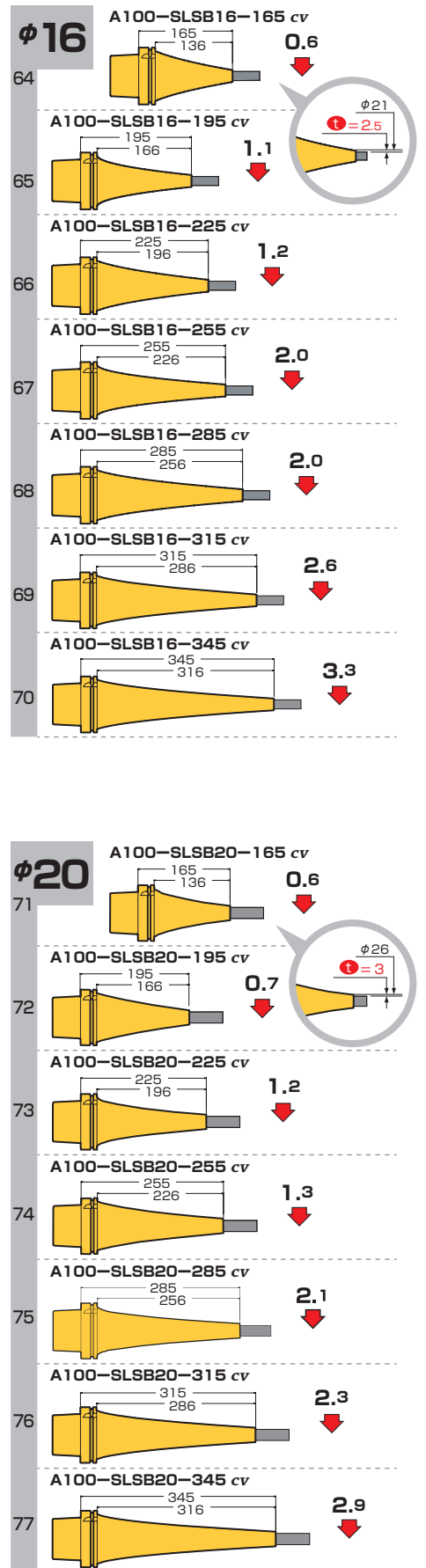
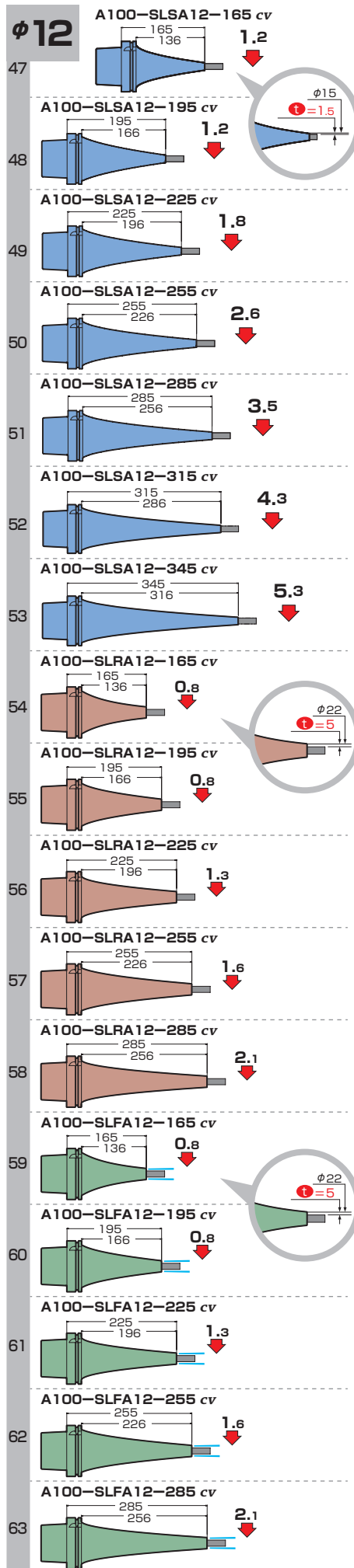
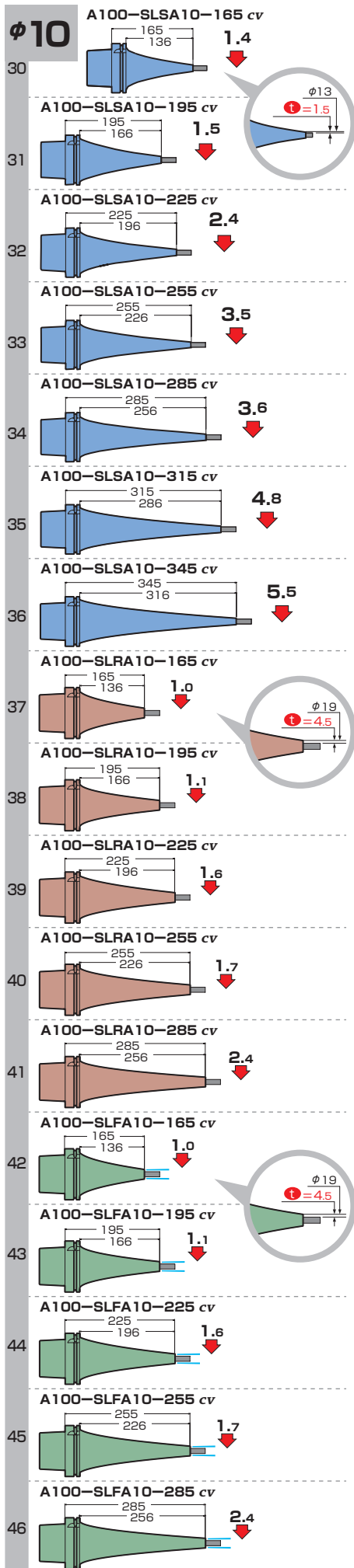

Dimensions E32

Deflection value
($\mu\text{m}/\text{kgf}$)

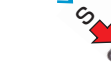

E32-SLSA6-120 cv

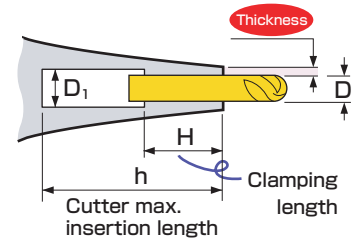
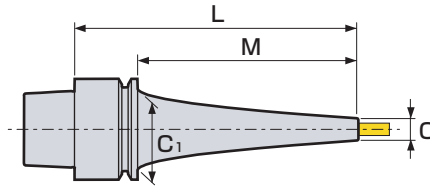

Scale model	CODE	ϕD	ϕC	Thick-ness	L	M	ϕC_1	ϕD_1	H	h	Kg	N	S
1	E32-SLSA 4- 60 cv	4	7	1.5	60	40	26	5	12	43	0.2	0.6	2.4
2	- 90 cv				90	70				73			0.8
3	-SLSA 6- 60 cv	6	9	1.5	60	40	26	7	18	43	0.2	0.7	1.9
4	- 90 cv				90	70				73			0.9
5	-SLSA 8- 60 cv	8	11	1.5	60	40	26	8.6	24	38	0.2	0.7	1.6
6	- 90 cv				90	70							1.0
7	-SLSA10- 60 cv	10	13	1.5	60	40	26	10.6	30	48	0.2	0.8	1.4
8	- 90 cv				90	70				60			1.1

$\phi 4$

E32-SLSA 4-60 cv

E32-SLSA 4-90 cv

$\phi 6$

E32-SLSA 6-60 cv

E32-SLSA 6-90 cv

$\phi 8$

E32-SLSA 8-60 cv

E32-SLSA 8-90 cv

$\phi 10$

E32-SLSA10-60 cv

E32-SLSA10-90 cv

For SLIMLINE MONO CURVE customers.

Please note that we changed model number for SLIMLINE MONO CURVE due to additional model lineup.

Example; Previous model no. : A63-SLSC6-120

New model no. : A63-SLSA6-120 CV

Dimensions E40

Deflection value
($\mu\text{m/kgf}$)



E40-SLSA8-150 cv

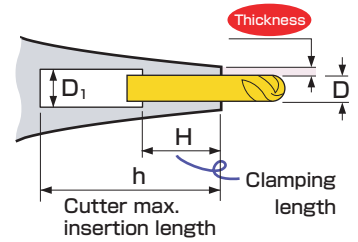
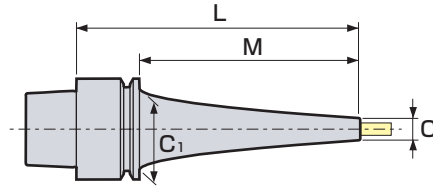

Scale model	CODE	ϕD	ϕC	Thick-ness	L	M	ϕC_1	ϕD_1	H	h	Kg	N	S			
1	E40-SLSA 4- 90 cv	4	7	1.5	90	70	34	5	12	74	0.3	1.5	2.9			
2	-120 cv				120	100				104				0.4	1.8	6.5
3	-150 cv				150	130				134						
4	-SLRA 4- 90 cv	4	10	3	90	70	34	5	12	74	0.4	1.6	2.0			
5	-120 cv				120	100				104				1.9	4.2	
6	-SLSA 6- 90 cv	6	9	1.5	90	70	34	7	18	74	0.3	1.6	2.5			
7	-120 cv				120	100				104				0.4	1.9	5.6
8	-150 cv				150	130				134						
9	-SLRA 6- 90 cv	6	13	3.5	90	70	34	7	18	74	0.4	1.7	1.7			
10	-120 cv				120	100				104				0.5	2.4	2.6
11	-SLSA 8- 90 cv	8	11	1.5	90	70	34	9	24	74	0.3	1.7	2.2			
12	-120 cv				120	100				104				0.4	2.0	3.4
13	-150 cv				150	130				134						
14	-SLRA 8- 90 cv	8	16	4	90	70	34	9	24	74	0.4	1.8	1.6			
15	-120 cv				120	100				104				0.5	2.5	2.4
16	-SLSA10- 90 cv	10	13	1.5	90	70	34	11	30	74	0.3	1.7	2.0			
17	-120 cv				120	100				104				0.4	2.4	3.2
18	-150 cv				150	130				134						
19	-SLRA10- 90 cv	10	19	4.5	90	70	34	11	30	74	0.4	2.1	1.1			
20	-120 cv				120	100				104				0.5	2.9	2.0

$\phi 4$

E40-SLSA 4- 90 cv $\phi 7$ $t=1.5$ \downarrow 2.9

E40-SLSA 4-120 cv \downarrow 6.5

E40-SLSA 4-150 cv \downarrow 8.6

E40-SLRA 4- 90 cv $\phi 10$ $t=3$ \downarrow 2.7

E40-SLRA 4-120 cv \downarrow 4.2

$\phi 6$

E40-SLSA 6- 90 cv $\phi 9$ $t=1.5$ \downarrow 2.5

E40-SLSA 6-120 cv \downarrow 5.6

E40-SLSA 6-150 cv \downarrow 7.7

E40-SLRA 6- 90 cv $\phi 13$ $t=3.5$ \downarrow 1.7

E40-SLRA 6-120 cv \downarrow 2.6

$\phi 8$

E40-SLSA 8- 90 cv $\phi 11$ $t=1.5$ \downarrow 2.2

E40-SLSA 8-120 cv \downarrow 3.4

E40-SLSA 8-150 cv \downarrow 5.1

E40-SLRA 8- 90 cv $\phi 16$ $t=4$ \downarrow 1.6

E40-SLRA 8-120 cv \downarrow 2.4

$\phi 10$

E40-SLSA10- 90 cv $\phi 13$ $t=1.5$ \downarrow 2.0

E40-SLSA10-120 cv \downarrow 3.2

E40-SLSA10-150 cv \downarrow 5.0

E40-SLRA10- 90 cv $\phi 19$ $t=4.5$ \downarrow 1.1

E40-SLRA10-120 cv \downarrow 2.0

Dimensions E50

Deflection value
($\mu\text{m}/\text{kgf}$)

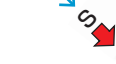

E50-SLSA6-120 cv

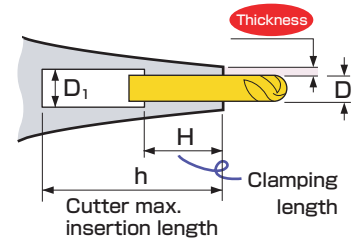
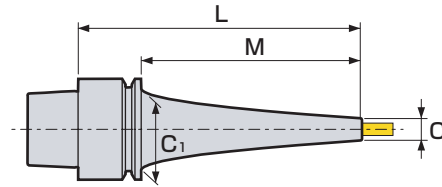

Scale model	CODE	ϕD	ϕC	Thick-ness	L	M	ϕC_1	ϕD_1	H	h	Kg	N	S			
1	E50-SLSA 4- 90 cv	4	7	1.5	90	64	42	5	12	74	0.6	2.2	1.8			
2	-120 cv				120	94				104				2.6	4.2	
3	-150 cv				150	124				134						0.7
4	-180 cv				180	154				164				0.8	3.5	
5	-SLRA 4-120 cv	4	10	3	120	94	42	5	12	104	0.7	2.8	2.7			
6	-150 cv				150	124				134				0.8	3.4	4.1
7	-SLSA 6- 90 cv	6	9	1.5	90	64	42	7	18	74	0.6	2.3	1.6			
8	-120 cv				120	94				104				2.7	3.5	
9	-150 cv				150	124				134						0.7
10	-180 cv				180	154				164				0.9	4.2	
11	-SLRA 6-120 cv	6	13	3.5	120	94	42	7	18	104	0.8	3.3	1.8			
12	-150 cv				150	124				132				0.9	4.0	2.7
13	-SLSA 8- 90 cv	8	11	1.5	90	64	42	9	24	74	0.6	2.5	1.4			
14	-120 cv				120	94				104				0.7	3.2	2.2
15	-150 cv				150	124				134						
16	-180 cv				180	154				164				0.8	4.2	7.1
17	-SLRA 8-120 cv	8	16	4	120	94	42	9	24	102	0.8	3.8	1.3			
18	-150 cv				150	124				132				0.9	4.0	2.7
19	-SLSA10- 90 cv	10	13	1.5	90	64	42	11	30	74	0.6	2.5	1.3			
20	-120 cv				120	94				104				0.7	3.3	2.1
21	-150 cv				150	124				134						
22	-180 cv				180	154				164				4.3	6.9	
23	-SLRA10-150 cv	10	19	4.5	150	124	42	11	30	132	0.9	4.4	2.2			

For SLIMLINE MONO CURVE customers.

Please note that we changed model number for SLIMLINE MONO CURVE due to additional model lineup.

Example; Previous model no. : **A63-SLSC6-120**

New model no. : **A63-SLSA6-120 CV**

φ4

E50-SLSA 4- 90 cv

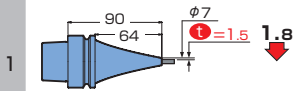

E50-SLSA 4-120 cv

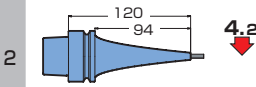

E50-SLSA 4-150 cv

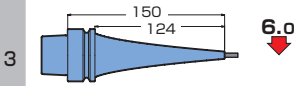

E50-SLSA 4-180 cv

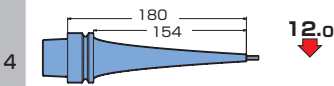

E50-SLRA 4-120 cv

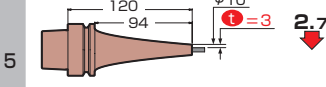

E50-SLRA 4-150 cv

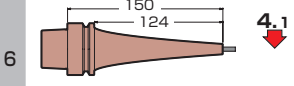

φ6

E50-SLSA 6- 90 cv

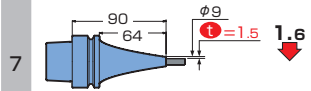

E50-SLSA 6-120 cv

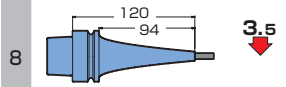

E50-SLSA 6-150 cv

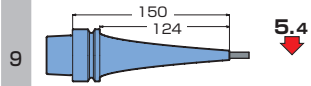

E50-SLSA 6-180 cv

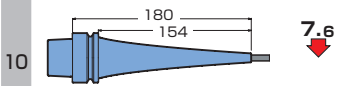

E50-SLRA 6-120 cv

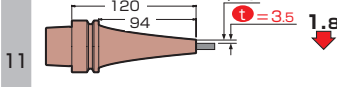

E50-SLRA 6-150 cv

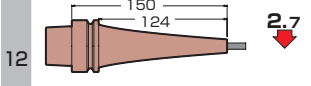

φ8

E50-SLSA 8- 90 cv

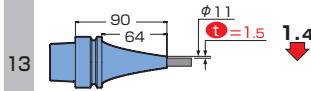

E50-SLSA 8-120 cv

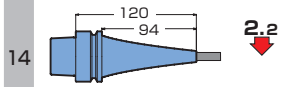

E50-SLSA 8-150 cv

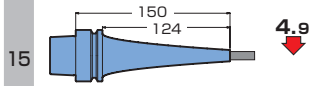

E50-SLSA 8-180 cv

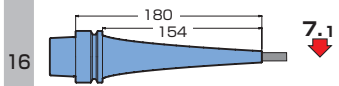

E50-SLRA 8-120 cv

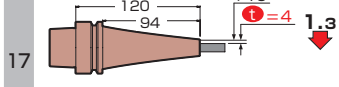

E50-SLRA 8-150 cv

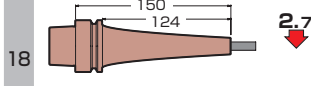

φ10

E50-SLSA10- 90 cv

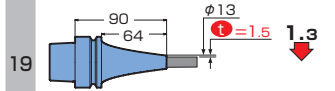

E50-SLSA10-120 cv

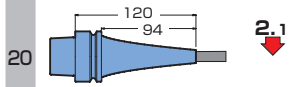

E50-SLSA10-150 cv

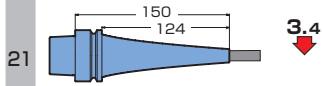

E50-SLSA10-180 cv

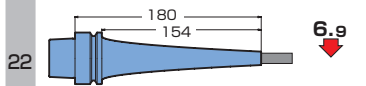

E50-SLRA10-150 cv

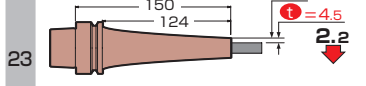

Dimensions F63

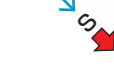

Deflection value
($\mu\text{m}/\text{kgf}$)

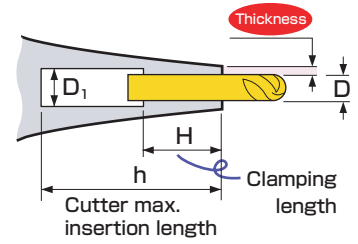
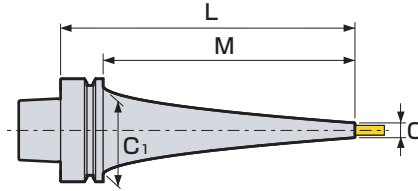

F63-SLSA6-90 cv



Scale model	CODE	ϕD	ϕC	Thick-ness	L	M	ϕC_1	ϕD_1	H	h	Kg	N	S			
1	F63-SLSA 4- 90 cv	4	7	1.5	90	64	53	5	12	65	0.9	2.7	1.8			
2	-120 cv				120	94				95				1.0	3.6	2.7
3	-150 cv				150	124				125				1.2	4.4	4.0
4	-180 cv				180	154				154				1.3	5.0	6.6
5	-210 cv				210	184				185					5.3	11.6
6	-240 cv				240	214				214				1.6	6.5	14.0
7	-270 cv				270	244				245				1.9	8.8	11.9
8	-300 cv				300	274				275				2.0	9.7	15.9
9	-SLRA 4-120 cv	4	10	3	120	94	53	5	12	95	1.0	3.6	1.9			
10	-150 cv				150	124				125				1.1	4.4	2.9
11	-180 cv				180	154				155				1.4	6.0	3.3
12	-210 cv				210	184				185				1.5	6.2	5.6
13	-SLSA 6- 90 cv	6	9	1.5	90	64	53	7	18	65	0.9	2.8	1.6			
14	-120 cv				120	94				95				1.0	3.6	2.3
15	-150 cv				150	124				125				1.2	4.4	3.6
16	-180 cv				180	154				154				1.3	5.2	5.7
17	-210 cv				210	184				184				1.5	6.4	7.3
18	-240 cv				240	214				214				1.6	6.7	12.0
19	-270 cv				270	244				245				2.0	9.7	8.5
20	-300 cv				300	274				275				2.2	10.6	11.7
21	-SLRA 6- 90 cv	6	13	3.5	90	64	53	7	18	65	1.0	3.4	0.8			
22	-120 cv				120	94				95				1.2	4.3	1.2
23	-150 cv				150	124				125				1.3	5.2	1.9
24	-180 cv				180	154				155				1.4	6.1	2.8
25	-210 cv				210	184				185				1.5	6.6	4.8
26	-SLFA 6- 90 cv	6	13	3.5	90	64	53	7	18	65	1.0	3.4	0.8			
27	-120 cv				120	94				95				1.2	4.3	1.2
28	-150 cv				150	124				125				1.3	5.2	1.9
29	-180 cv				180	154				155				1.4	6.1	2.8
30	-210 cv				210	184				185				1.5	6.6	4.8
31	-SLSA 8- 90 cv	8	11	1.5	90	64	53	9	24	65	0.9	2.9	1.4			
32	-120 cv				120	94				94				1.1	3.8	2.0
33	-150 cv				150	124				124				1.3	5.0	2.7
34	-180 cv				180	154				155					5.2	5.0
35	-210 cv				210	184				184				1.5	6.6	6.6
36	-240 cv				240	214				214				1.8	7.8	8.3
37	-270 cv				270	244				244				2.1	10.7	6.9
38	-300 cv				300	274				274				2.3	11.9	8.9
39	-SLRA 8- 90 cv	8	16	4	90	64	53	9	24	65	1.0	3.4	0.7			
40	-120 cv				120	94				95				1.2	4.6	1.0
41	-150 cv				150	124				125				1.4	5.9	1.4
42	-180 cv				180	154				155				1.6	7.0	2.0
43	-210 cv				210	184				185					7.6	3.5
44	-SLFA 8- 90 cv	8	16	4	90	64	53	9	24	65	1.0	3.4	0.7			
45	-120 cv				120	94				95				1.2	4.6	1.0
46	-150 cv				150	124				125				1.4	5.9	1.4
47	-180 cv				180	154				155				1.6	7.0	2.0
48	-210 cv				210	184				185					7.6	3.5

Scale model	CODE	ϕD	ϕC	Thick-ness	L	M	ϕC_1	ϕD_1	H	h	 Kg	 N	 S
49	F63-SLSA10- 90 cv	10	13	1.5	90	64	53	11	30	65	0.9	2.9	1.3
50	-120 cv				120	94				95	1.2	4.4	
51	-150 cv				150	124				125	1.3	5.2	2.2
52	-180 cv				180	154				154	1.5	6.3	3.4
53	-210 cv				210	184				184	1.6	6.8	6.0
54	-240 cv				240	214				212	2.0	9.4	5.8
55	-270 cv				270	244				244	2.1	10.9	6.6
56	-300 cv				300	274				274	2.3	12.2	8.5
57	-SLRA10- 90 cv	10	19	4.5	90	64	53	11	30	65	1.0	3.5	0.6
58	-120 cv				120	94				95	1.2	4.6	0.9
59	-150 cv				150	124				125	1.4	5.8	1.4
60	-180 cv				180	154				155	1.6	7.2	2.0
61	-210 cv				210	184				185		8.0	3.1
62	-SLFA10- 90 cv				10	19				4.5	90	64	53
63	-120 cv	120	94	95			1.2	4.6	0.9				
64	-150 cv	150	124	125			1.4	5.8	1.4				
65	-180 cv	180	154	155			1.6	7.2	2.0				
66	-210 cv	210	184	185				8.0	3.1				
67	-SLSA12- 90 cv	12	15	1.5	90	64	53	14	30	64	1.0	3.4	0.9
68	-120 cv				120	94		94		1.2	4.7	1.2	
69	-150 cv				150	124		124		1.3	5.2	2.4	
70	-180 cv				180	154		154		1.5	6.5	3.3	
71	-210 cv				210	184		184		1.7	7.7	4.6	
72	-240 cv				240	214		212		2.0	9.6	5.5	
73	-270 cv				270	244		244		2.2	11.8	5.4	
74	-SLRA12- 90 cv	12	22	5	90	64	53	14	30	64	1.0	3.6	0.6
75	-120 cv				120	94		94		1.3	5.5	0.7	
76	-150 cv				150	124		124		1.5	6.7	1.1	
77	-180 cv				180	154		154		1.6	7.5	1.8	
78	-210 cv				210	184		184		1.7	8.5	2.8	
79	-SLFA12- 90 cv	12	22	5	90	64	53	14	30	64	1.0	3.6	0.6
80	-120 cv				120	94		94		1.3	5.5	0.7	
81	-150 cv				150	124		124		1.5	6.7	1.1	
82	-180 cv				180	154		154		1.6	7.5	1.8	
83	-210 cv				210	184		184		1.7	8.5	2.8	
84	-SLSB16- 90 cv	16	21	2.5	90	64	53	17	32	62	1.1	3.9	0.6
85	-120 cv				120	94				92	1.4	5.8	0.8
86	-150 cv				150	124				122	1.5	6.9	1.5
87	-180 cv				180	154				152	1.9	8.8	1.9
88	-210 cv				210	184				182	2.0	9.9	3.0
89	-240 cv				240	214				212	2.3	11.8	3.7
90	-270 cv				270	244				242	2.7	13.7	4.6
91	-SLSB20- 90 cv	20	26	3	90	64	51	21	40	62	1.1	4.2	0.5
92	-120 cv				120	94				92	1.4	6.2	0.8
93	-150 cv				150	124				122	1.6	7.6	1.3
94	-180 cv				180	154				152	2.0	9.6	1.8
95	-210 cv				210	184				182	2.3	11.6	2.3
96	-240 cv				240	214				212	2.6	13.7	3.0
97	-270 cv				270	244				242	3.1	16.3	3.4

For SLIMLINE MONO CURVE customers.

Please note that we changed model number for SLIMLINE MONO CURVE due to additional model lineup.

Example; Previous model no. : **A63-SLSC6-120**

New model no. : **A63-SLSA6-120 CV**

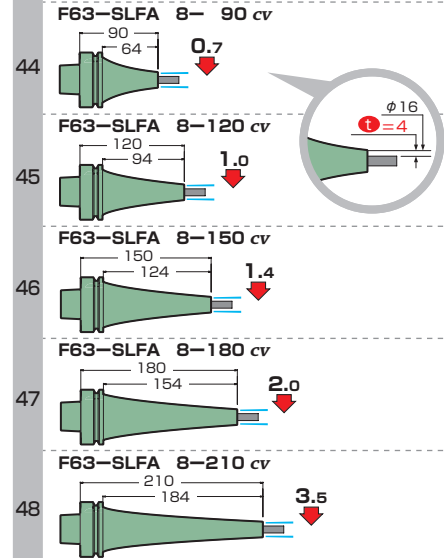
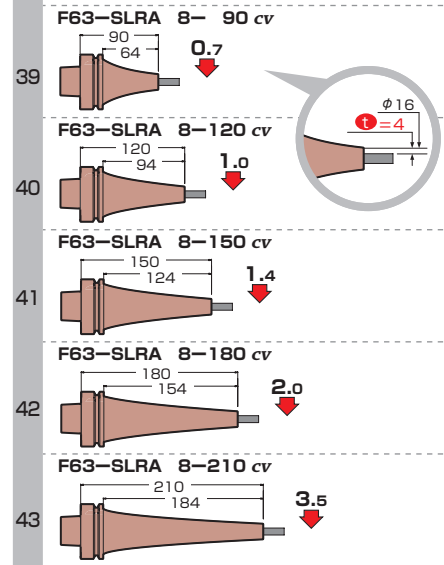
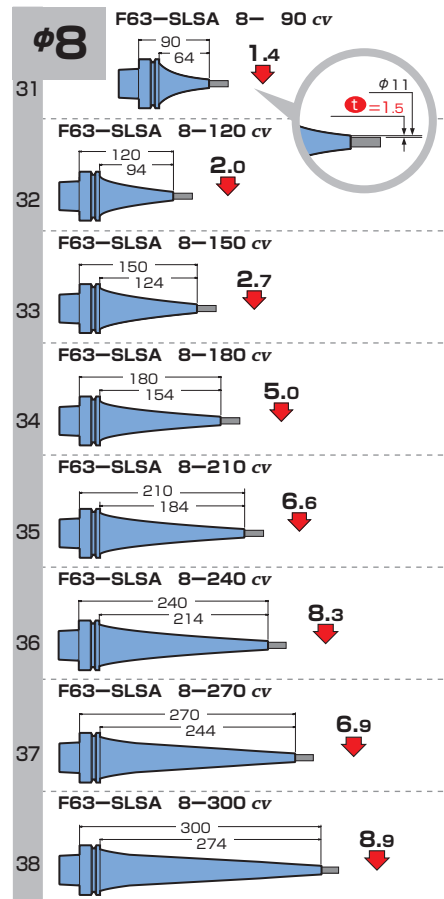
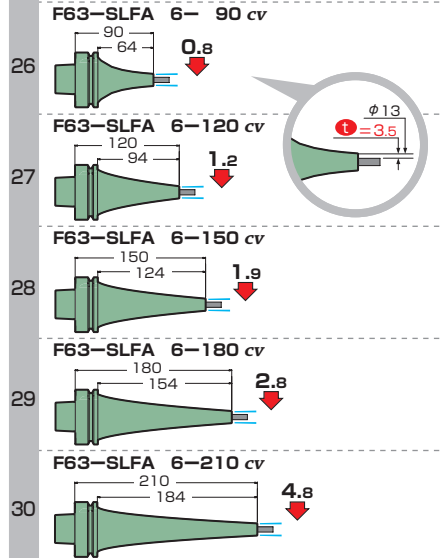
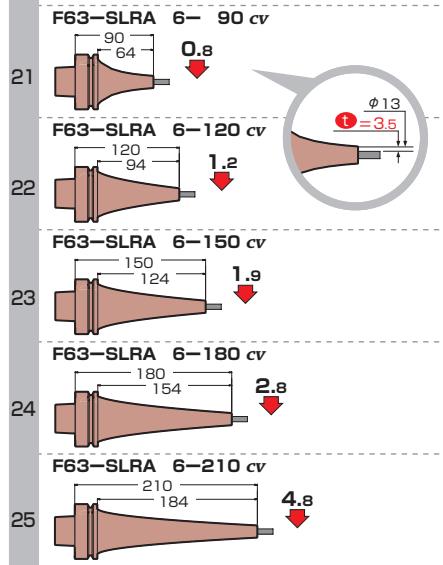
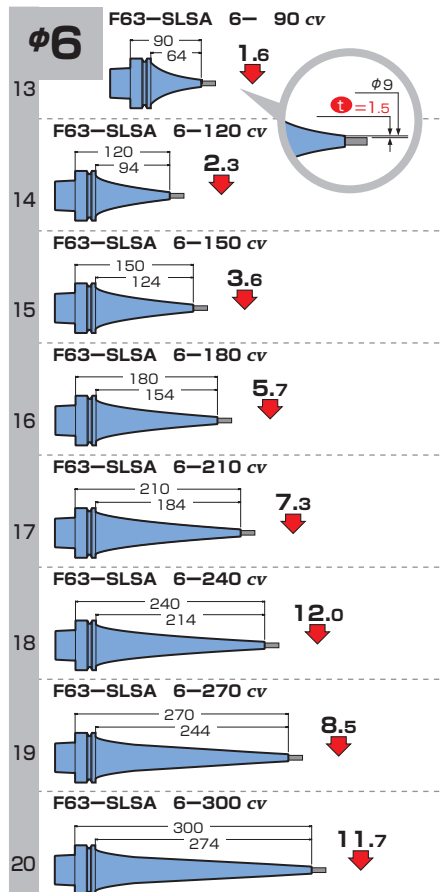
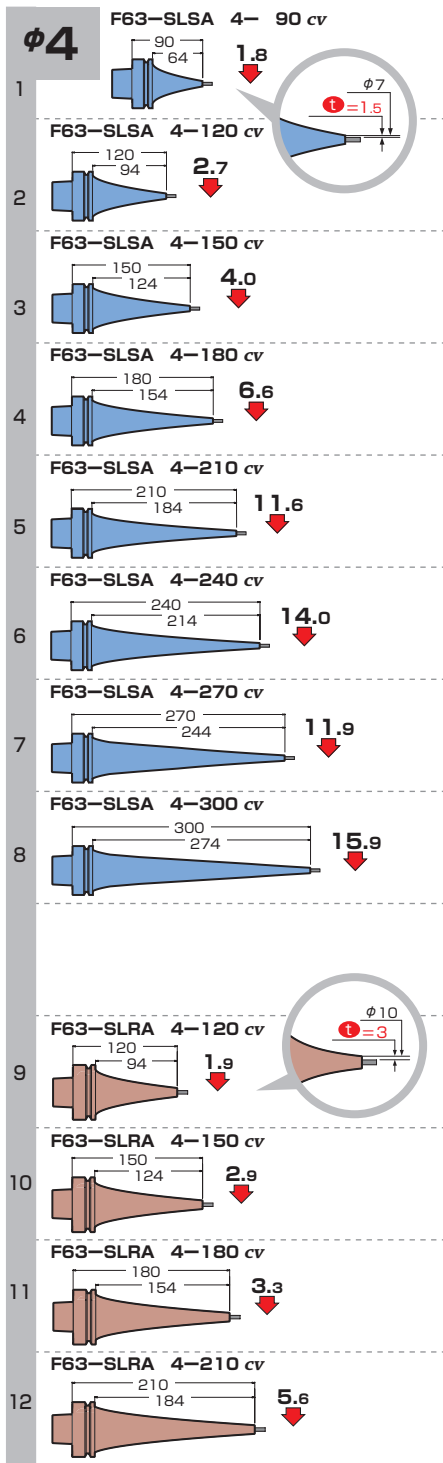

F63

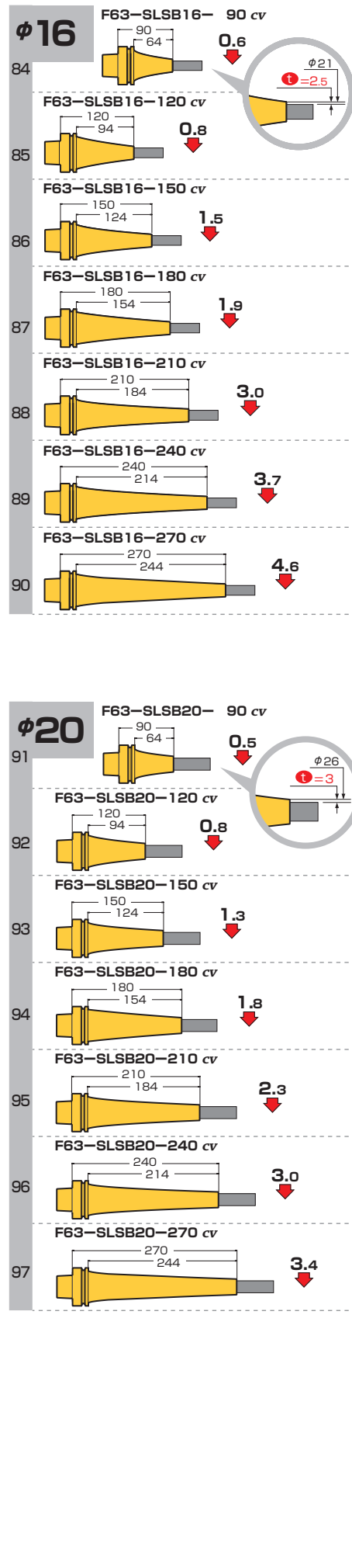
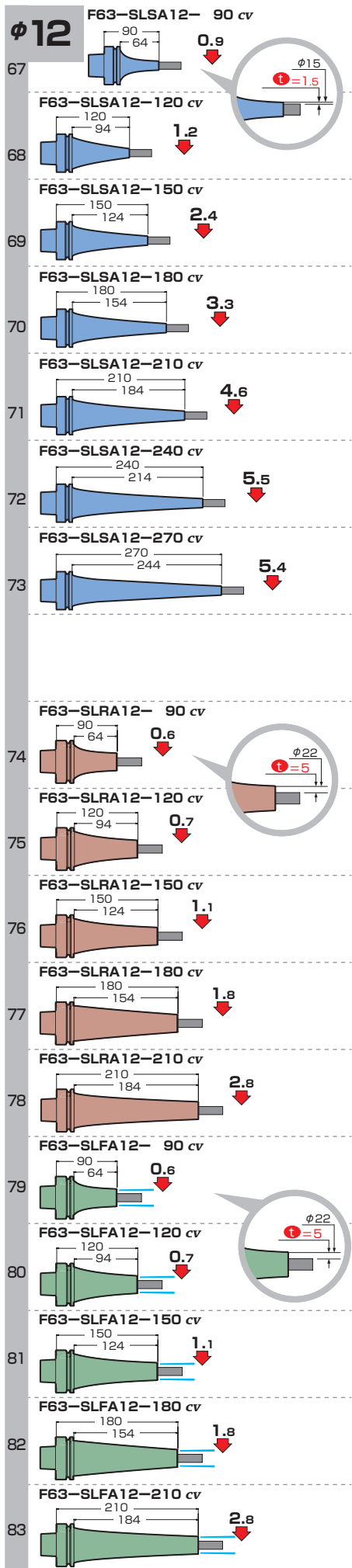
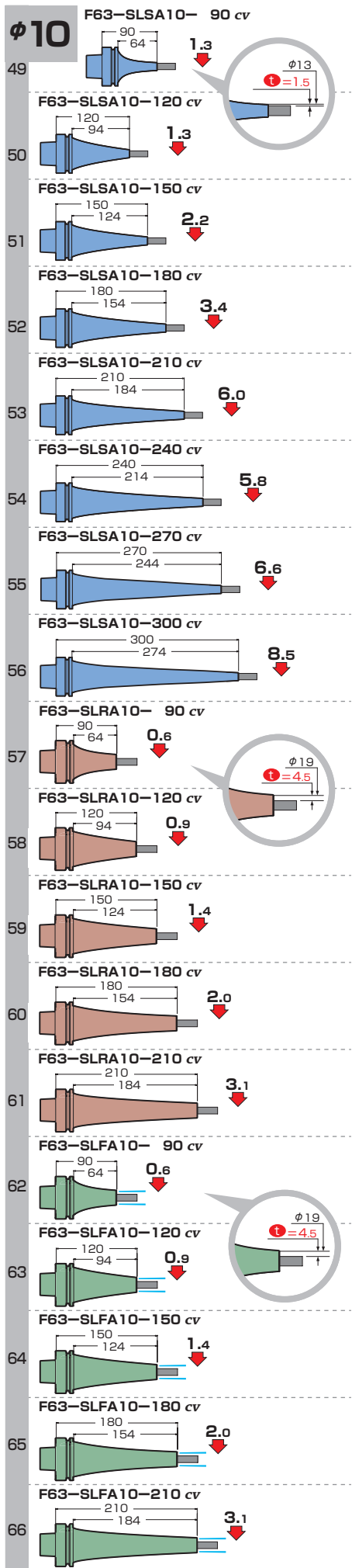

Dimensions
F80PD
For Makino

Deflection value
($\mu\text{m}/\text{kgf}$)

ω



F80PD-SLRB16-75 cv

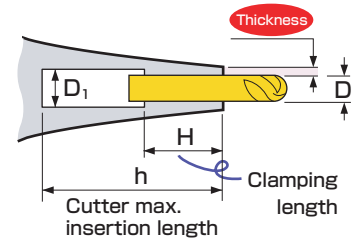
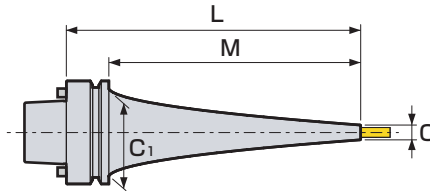

Scale model	CODE	ϕD	ϕC	Thick-ness	L	M	ϕC_1	ϕD_1	H	h	Kg	N	S	
1	F80PD-SLRB12- 75 cv	12	26	7	75	49	67	13	30	48	1.4	4.8	0.4	
2	- 90 cv				90	64				63		5.3	0.5	
3	-120 cv				120	94				93		1.9	8.5	
4	-180 cv				180	154				153		2.5	12.8	0.9
5	-240 cv				240	214				213		2.9	15.7	1.8
6	F80PD-SLRB16- 75 cv	16	32	8	75	49	67	17	32	48	1.5	5.4	0.3	
7	- 90 cv				90	64				63		1.6		6.7
8	-120 cv				120	94				93		2.1	9.9	0.4
9	-180 cv				180	154				153		2.7	14.1	0.8
10	-240 cv				240	214				213		3.4	19.5	1.3
11	F80PD-SLRB20- 75 cv	20	38	9	75	49	67	21	40	48	1.5	5.8	0.3	
12	- 90 cv				90	64				63		1.7	7.2	0.2
13	-120 cv				120	94				93		2.1	10.5	0.4
14	-180 cv				180	154				153		2.8	15.8	0.7
15	-240 cv				240	214				213		3.7	22.1	1.1
16	F80PD-SLRB25- 75 cv	25	45	10	75	49	67	26	42	1.6	6.6	0.2		
17	- 90 cv				90	64			45		63		1.9	8.6
18	-120 cv				120	94			93		2.3	11.9	0.3	
19	-180 cv				180	154			153		3.1	18.6	0.6	
20	-240 cv				240	214			213		4.1	25.2	1.0	

For SLIMLINE MONO CURVE customers.

Please note that we changed model number for SLIMLINE MONO CURVE due to additional model lineup.

Example; Previous model no. : **A63-SLSC6-120**

New model no. : **A63-SLSA6-120 CV**

φ12

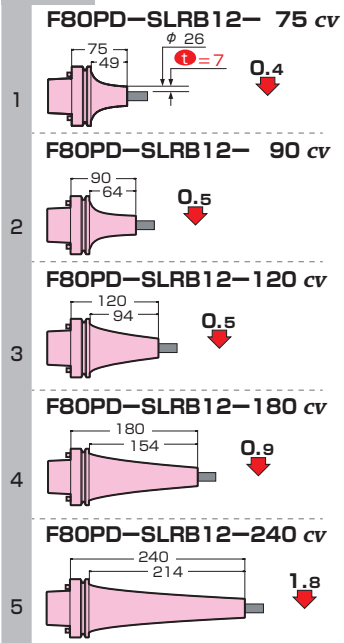

φ16

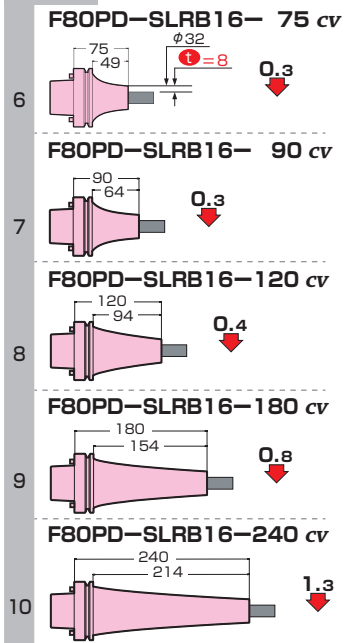

φ20

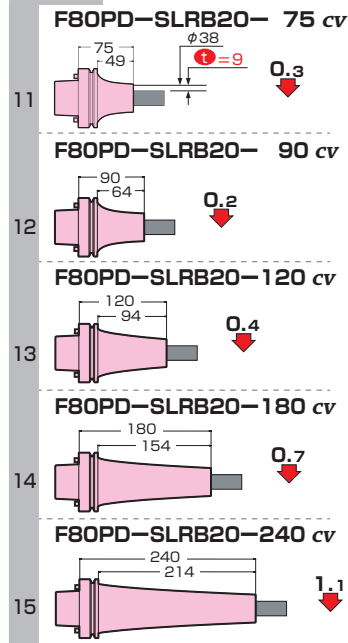

φ25

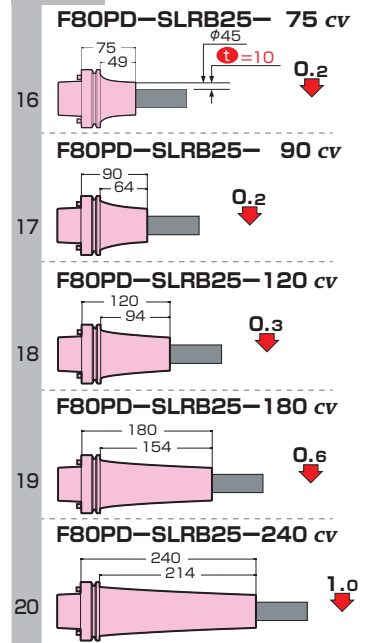

MSTcorporation

1738 Kita-tahara, ikoma, Nara 630-0142 Japan
TEL : +81 (0)743 78 1931
FAX : +81 (0)743 78 3854

<http://www.mst-corp.co.jp>