

# TOOL SET UP STATION

**MST** corporation



MAINTENANCE  
for  
Tool Holder  
and  
Cutting Tool



**6S DESK** [Work table]

Ensure safe and comfortable tool settings!  
Improves the work environment in the factory!

**CLEAN BOX** [Holder · Cutting Tool  
Washing Machine]

Wash the tooling holders, collets, nuts, and cutting tools thoroughly to maintain their high precision.

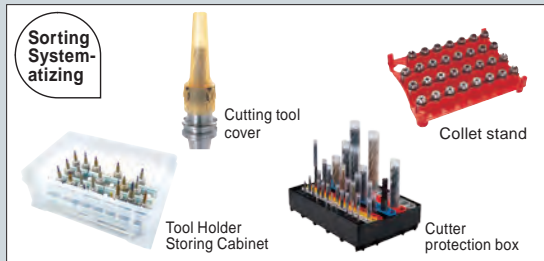

**MST** corporation

1809



# TOOL SET UP STATION

## Work table **6S DESK**

- Helps in the rapid implementation of the five S's in your factory.
- Compact and space saving.
- Do-it-yourself style allows you to do the assembly.



CODE
6SD-01

### White board and Punched board

Useful as a bulletin board or message board, and for attaching drawings. Freely mounting position on the left or right side.

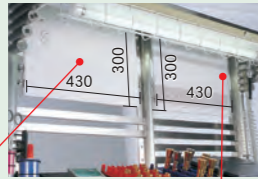

White board Punched board

### Shelf Board

Shelf is deep enough for a laptop computer, and the shelf can be attached at whatever height you desire.

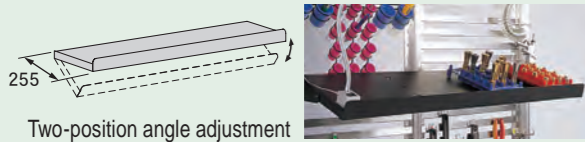

### Hook base panel



Arbitrary attachment and recombination

Effective utilization of a rear space

### Tool insert stand (Option)

Insert and store frequently used hand tools, stationary, etc.



Tool insert stand 5 Movable model (5 pockets)

Tool insert stand 16 Fixed model (16 pockets)

### Dust Shooter (Option)

Easy trash separation.

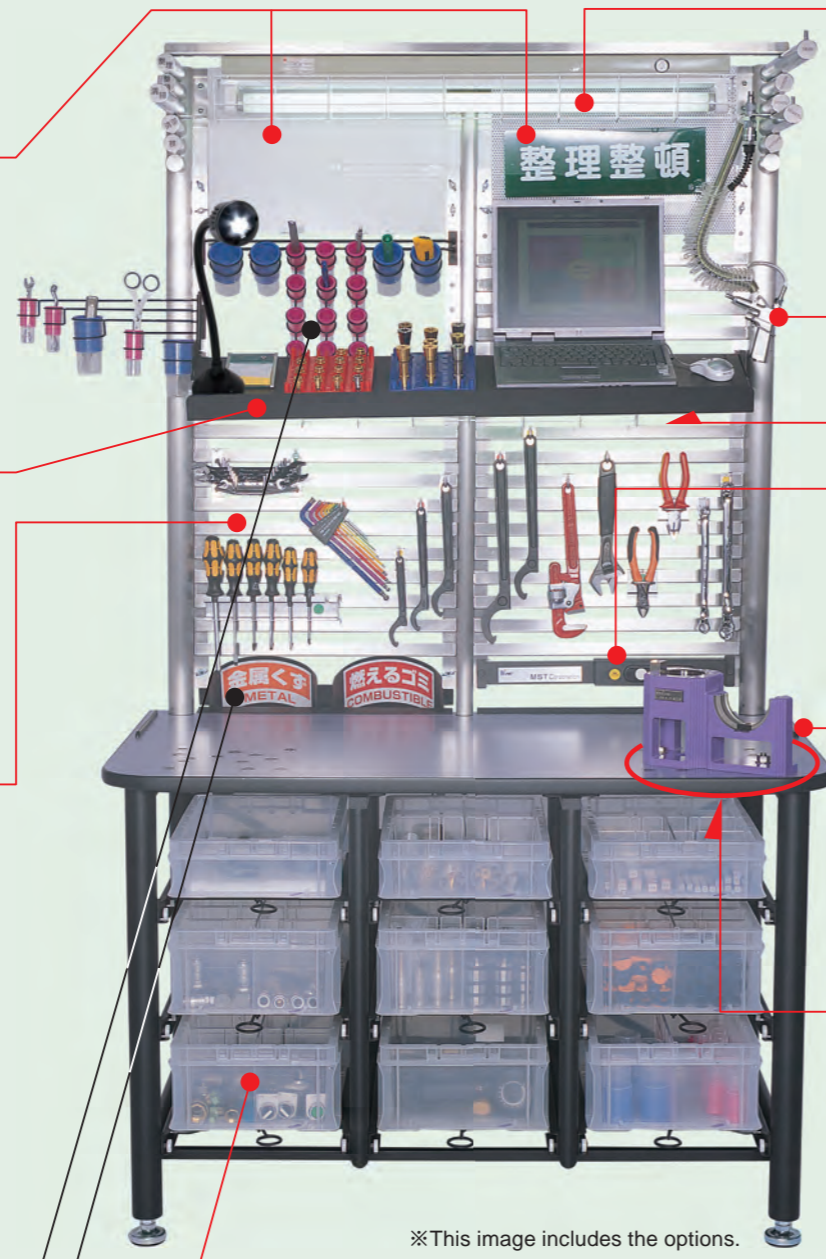

※This image includes the options.

### Container box

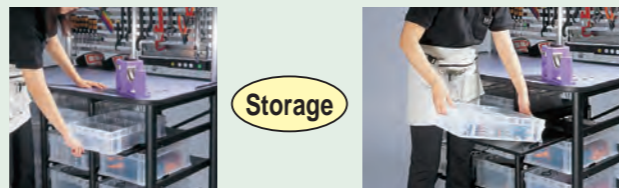

Storage

Can be removed and carried.



Organizing

The see-through box allows easy storage and organizing.

Optional dividers allow you to easily organize and systematize items.

### Upper lighting

Safety light cover.

### Air gun

Can be mounted on either the right or left.

### Lower lighting

Brightly lit, safe work space

### Lighting switch and socket

Upper lighting (32W) and under shelf lighting (20W) (max. capacity 1,500W)

### Safety stopper

Prevents dropping of cutting tools and tool holders.

### Tabletop

The tool setup stand (sold separately) can be installed anywhere using the tabletop holes. No need to put your own holes in the tabletop.

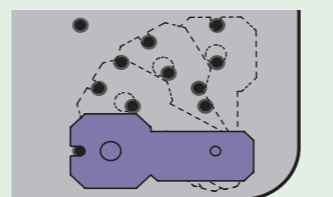
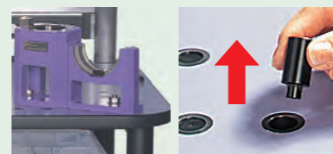

### Tool set up stand

Φ P.7



### Dimensions

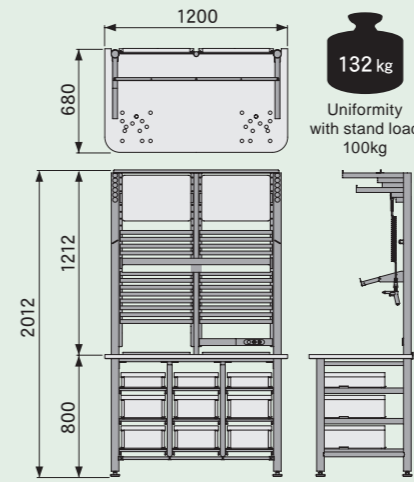

### Std. Access.

CODE	Description	Q'ty	Description	Q'ty
6SD-FBP	Hook base panel	12pcs.	Shelf Board	1pc.
-FS	Short hook	3pcs.	Upper lighting / Lower lighting ※Select 50Hz or 60Hz	1ea.
-FL	Long hook	2pcs.	Power code set (Socket / Lighting / switch / Power code)	1set
-UFS	U-type short hook	3pcs.		
-UFL	U-type long hook	1pc.	White board Marker pen for whiteboard Whiteboard eraser Magnet pocket Punched board Name seal set Magnets(3pcs.) Memo book	1set
-FSP	Hook for spanner	1pc.		
-FDR	Hook for driver	1pc.		
CN -103	Container box	3pcs.		
-150		6pcs.		
6SD-AIR	Air gun set	1set		

- Caution
- Assembly by buyer.
  - Customers pay the shipping cost.
  - 100V electric power supply (transformer is required)

### Option

#### Side table

CODE	Uniformity with stand load :40kg
6SD-STB	

Side Table for the 6S DESK

#### Std. Access.

- Container box (CN-103) (1pc.)
- Container box (CN-150) (2pcs.)
- Lid for Container Box (3pcs.)



#### Dust Shooter

CODE
6SD-DST

Comes with two kinds of sign seals.

- ※Trash cans are not provided. Please prepare it by yourself.



#### Tool insert stand 5

CODE	Attachment q'ty
6SD-IS 5	5pcs.

5-pocket movable model



#### Tool insert stand 16

CODE	Attachment q'ty
6SD-IS16	16pcs.

16-pocket fixed model



### Consumables / Replacement parts

#### Container box

CODE	h	Capacity	Q'ty
CN-103-3	103 (88)	8 l	3pcs.
-150-3	150 (135)	12 l	

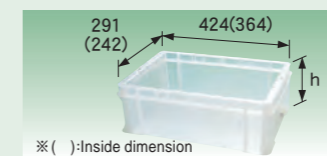

※ ( ) Inside dimension

#### Lid for container box

CODE	Q'ty
CN-FT-3	3pcs.



※Lockable

#### Dividers for storage cabinet

CODE	Required box	Q'ty
CN-S 84-3	CN-103	9 pcs. (for 6 rooms)
-S135-3	-150	(Container box 3 pcs / set)



#### Hook base panel

CODE	Q'ty
6SD-FBP	2pcs.

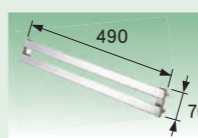

#### Air gun set

CODE
6SD-AIR



#### Hook

CODE	Q'ty
6SD-FS	5pcs.



CODE	Q'ty
6SD-UFS	5pcs.

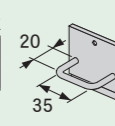

CODE	Q'ty
6SD-FSP	1pc.

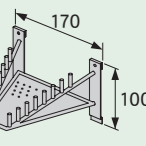

CODE	Q'ty
6SD-FL	5pcs.



CODE	Q'ty
6SD-UFL	5pcs.

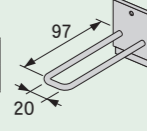

CODE	Q'ty
6SD-FDR	1pc.

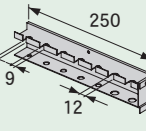



# TOOL SET UP STATION

## Tool washing machine **CLEAN BOX**

- Wash tool holders, cutting tools and jig fixtures.
- No plumbing required.
- Safe cleaning system using water.
- Built-in water heater improves washing capability.

For more information



CODE
CBX-01

### Compact built-in sink



#### Automatic washing space

Shoots cleaning fluid from 18 location nozzles.



#### Hand washing space

Heavy dirt can be washed off using the hand nozzle brush and hot water (40°C/104°F)



Built-in sink with an overflow drain allows pre-soaked washing.

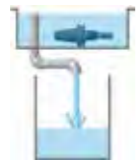

Light dirt can be washed off using automatic washing.

Heavy dirt can be washed off by hand.

### Top cover

Top cover of washing unit can be opened and closed with one hand.

Comes with an automatic shutoff function for the washing cycle.

Automatic washing stops automatically when the top cover is lifted during operation.



### Washing Unit

18 nozzles shoot hot water from every angle to wash off all the dirt.



### Timer operating mode

Operation can be stopped automatically using the clock timer. (The time can be set arbitrarily, up to 12 min.)



### Tank

The use of heated cleaning fluid (40°C) increases the cleaning power and makes cleaning easy even in the winter.



Tank can be removed for washing.



Comes with built-in heater (3kW) standard.

### Outer sink cover

Prevents splashing of the washing cleaner.

### Hand nozzle

Easy to attach and detach.

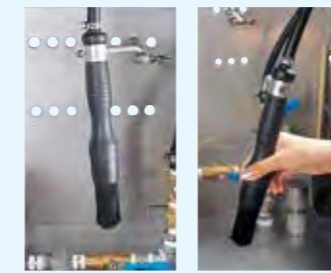

Attach

Remove

### Filter

Can be changed easily when it becomes dirty.



Main filter

Sub-filter

### Dimensions

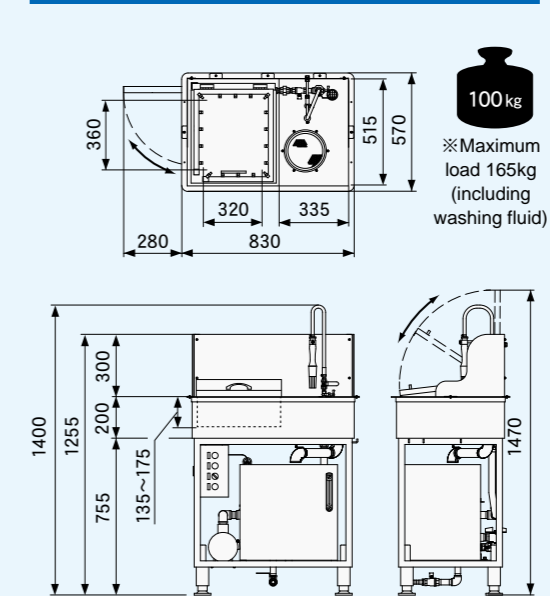

### Specification

Material	SU304 (Sink, Tank, Cleaning unit) SS400 (Base frame)
Tank	Approx. 65L (Level gauge with thermometer is standard accessory.)
Pump	0.3~0.51kW (50/60Hz) (Produced by Grundfos)
Heater	3kW (with temperature control)
Weight	Approx. 100kg (165kg, including cleaning fluid)
Voltage	3-phase 200V (Rated 15A)

### Std. Access.

CODE	Description	Q'ty
CBX-HNZ	Hand nozzle	1pc.
-MFIL	Main filter	2pcs.
-SFIL	Sub-filter	2pcs.
-TRP	Drain trap	1pc.
-GSTP	Rubber drain plug	1pc.
-WBSK	Washing basket	1pc.
-WTBL	Washing table	1pc.
	Sink outer cover	1set
	Hook	2pcs.
	Bamboo brush	1pc.
	Primary power code (plug attached 15m)	1pc.

- Caution
- Be sure to use water-soluble cleaning fluid.
  - Customers pay the shipping cost.
  - 200V electric power supply (transformer is required)

### Option

#### Draining basket

CODE	Uniformity with stand load 40kg
CBX-SBX	■ Std. Access. • Triple hook

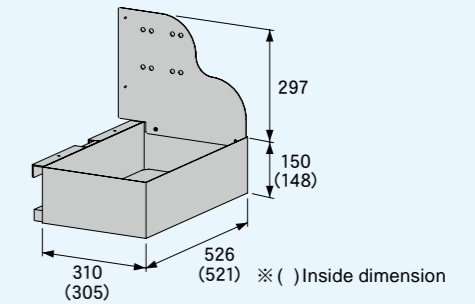

Used for draining, air blowing, rust-proofing, etc.  
Can be attached to either the right or left side of the unit.

### Consumables / Replacement parts

#### Washing basket

CODE	
CBX-WBSK	Collet and small parts can be washed.

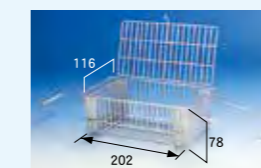

#### Washing table

CODE	
CBX-WTBL	Used in a sink as an auxiliary table when washing by hand.

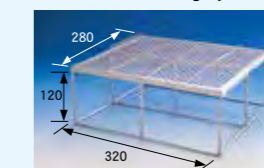

#### Main filter

CODE	Q'ty
CBX-MFIL	5pcs.



#### Hand nozzle

CODE	
CBX-HNZ	



#### Drain trap

CODE	
CBX-TRP	



#### Sub-filter

CODE	Q'ty
CBX-SFIL	3pcs.



#### Rubber drain plug

CODE	
CBX-GSTP	



#### Cleaning fluid

CODE	
CBX-EKI	

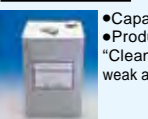

• Capacity 18ℓ  
• Product name: "Clean Super 285" weak alkaline cleaner

⚠ Be sure to use water-soluble cleaning fluid.

The sink, washing unit and tank are made of stainless steel, resulting in easy maintenance and less staining.

The maintaining machine spindle run-out accuracy allows superior machining quality. Maximizes tool holder performance!

Periodically checking the run-out accuracy will result in superior machining.

- ▷ Light-weight(20% lighter), hollow design makes it easy to use.
- ▷ The actual measurement values are marked on the body.

Length	Diameter	Runout accuracy	Phase of run-out
--------	----------	-----------------	------------------

- ▷ Ideal for setting Z axis datum.
- ▷ Reasonable price.

**You can recognize the exact run-out accuracy and the highest run-out of the spindle.**

You can check the spindle condition more precisely using the run-out value and position marked on the body.

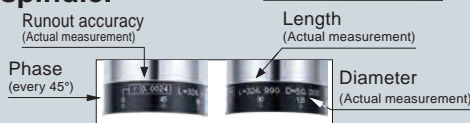

**It can be installed into the spindle in every phase.**

There is no drive-key groove, so measurements can be made without worrying about the phase.

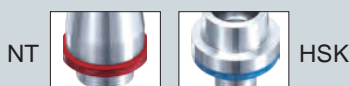

**Handy CMA type**

Allows you to check the dynamic accuracy thanks to optional balance adjustment.



**The name ring and scale ring protect it from scratches and dents.**

The taper area and straight area do not touch the table surface even if they are placed horizontally.

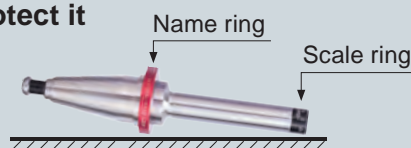

**Full-fledged CMB type**

Z-axis deflection and spindle travel accuracy can be measured.

	CODE	Fig.	φD	φD1	L	L1	L2	L3	Kg
BT / DIN / CAT.	NT30 -CMA20-125	1	20	32	125	45	65	15	0.7
	NT40 -CMA25-175	2	25	42	175	50	110		1.3
	NT50 -CMA30-225		30	53	225	65	145		3.5
	NT30 -CMB30-175	1	30	32	175	45	115	15	1.0
	NT40 -CMB40-325	2	40	42	325		265		2.8
	NT50 -CMB50-325		50	53		60	250		5.7
For both HSK-A and HSK-E	HSK32 -CMA20-125	3	20	26	125	35	75	15	0.4
	HSK40 -CMA20-125			32		45	65		0.5
	HSK50 -CMA25-175		25	42	175	50	110		1.0
	HSK63 -CMA25-175								1.2
	HSK80 -CMA30-225		30	53	225	65	145		2.2
	HSK100-CMA30-225								3.0
	HSK125-CMA30-225								4.1
	HSK32 -CMB25-175	3	25	26	175	35	125	15	0.7
	HSK40 -CMB30-175			30		32	40		120
	HSK50 -CMB40-225		40	42	225	45	165		1.8
	HSK63 -CMB40-325				325		265		2.7
	HSK80 -CMB50-325		50	53		60	250		4.4
	HSK100-CMB50-325								5.2
	HSK125-CMB50-325								6.3
	Exclusive use for HSK-F	HSK63F-CMA25-175	3	25	42	175	50	110	15
HSK80F-CMA30-225		30		53	225	65	145	2.3	
HSK63F-CMB40-325		3	40	42	325	45	265	15	2.7
HSK80F-CMB50-325			50	53		60	250		4.5

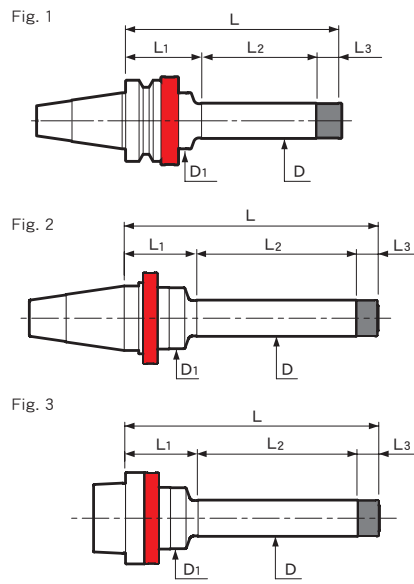

**Exclusive retention knob**

CODE	Shank
P-576	CAT.40
-575	CAT.50
-578	DIN40
-577	DIN50

- Std. Access.
- Accuracy inspection sheet

- Option
- Coolant duct(HSK-A) • Retention knob(BT)
  - Special retention knob(CAT. / DIN)
  - Balance adjustment (only for CMA type) less than G2.5 / 30000min<sup>-1</sup>
  - \*Please order by adding "BL" to the end of the code. (Ex. : HSK63-CMA25-175 BL)

- Note
- NT type is available for BT/CAT. and DIN spindle by changing the retention knob.
  - HSK type is available for both HSK-A and HSK-E spindles. • HSK-F type is available only for HSK-F spindle.
  - A special design retention knob is required for CAT./DIN spindle. A market standard retention knob for ANSI/DIN/ISO is not available. Contact us for the details.
- Caution
- Use a market standard retention knob for the BT spindle.
  - NT30 type can be installed into a spindle at 0° and 180°.
  - A.T.C is not available. (except for NT30)

**The sub-zero treatment prevents secular change.**



# Tool tightening stand Tool set up stand

The setup time can be shortened. Not only can you mount cutting tools simply and quickly without using other tools, but also clamping collets and retention knobs!

**フェボール**  
**Petit Ball 40**  
BT40/DIN40/CAT.40

**マキューブ**  
**MY CUBE 50**  
BT50/DIN50/CAT.50  
**マキューブ**  
**MY CUBE 100**  
HSK-A100/T100

Vise clamping type  
**HFシリーズ**  
BT30/ BT40/ BT50  
HSK-A40/ A50/ A63/ A100  
E32/ E40/ E50/ F63



Freely set vertically or horizontally

Accuracy assured

Made from a special resin material that prevents damage to the taper.

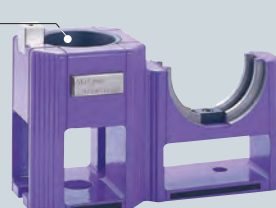

Affordable



## Petit Ball / MY CUBE

CODE	Shank type	Kg
Petit Ball40	BT40/DIN40/CAT.40	6.1
MY CUBE 50	BT50/DIN50/CAT.50	9.7
MY CUBE100	HSK-A100, T100	9.6

### Option

- Adapter(Petit Ball40, MY CUBE50)

### Std. Access.

- Name plate

### Caution

- No mounting bolts are provided.  
Use two M8 bolts for mounting.

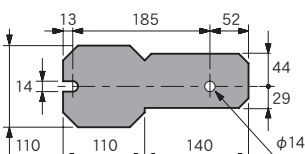
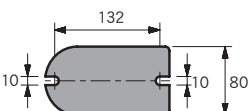
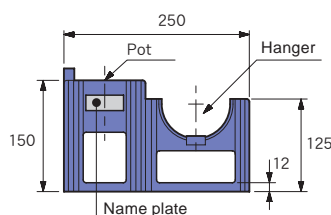
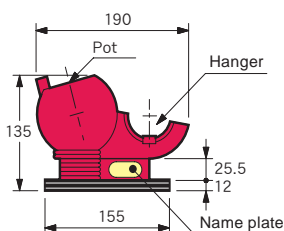

## Adapter

Multi-purpose usage

CODE	Boring head	Adapter	Shank type
AP40-T30V	Petit Ball 40	For pot	BT30
-T30H		For hanger	BT30
-S25H			ST25T-DTB7
-S32H			ST32T-DTB7, 12
AP50-T30V	MY CUBE 50	For pot	BT30
-T40V			BT40/DIN40/CAT.40
-A63V			HSK-A63, T63
-F63V			HSK-F63
AP50-T30H		For hanger	BT30
			BT40
			HSK-A63, T63
			HSK-F63
			ST25T-DTB7
			ST32T-DTB7, 12



Adapter for hanger

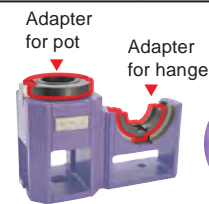

Your company name is inscribed on the name plate. Up to 12 uppercase letters including numbers and hyphens.



Petit Ball



MY CUBE

## HF series

CODE	Fig.	Shank type	H	W	t	Kg
HF-BT30	1	BT30	77	70	30	0.8
-BT40		BT40	90	90	37	1.2
-BT50		BT50	—	—	—	2.2
HF-A40	1	HSK-A40, T40	72	60	30	0.8
-A50		-A50, T50	77	70	37	1.0
-A63		-A63, T63	87	90	—	1.2
-A100		-A100, T100	—	—	—	2.1
HF-E32	3	HSK-E32	98	64	—	1.0
-E40		-E40	100	70	—	1.1
-E50		-E50	106	80	—	1.3
HF-F63		-F63	120	90	—	1.6

Fig. 1

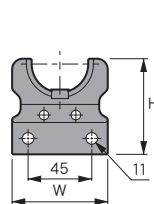

Fig. 2

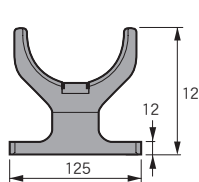
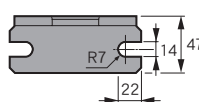
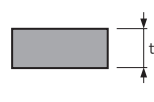
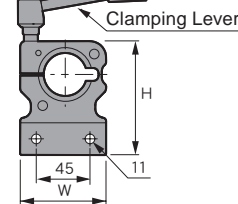

Fig. 3



# Cutting tool cover TOOL CAP

See-through tool cover.

You can take care of your tools safely and simply.

- ▷ Prevents chipping and damage to your cutting tools from striking other cutters during storage.
- ▷ Prevent getting injured when taking the tool holder in and out or when carrying.
- ▷ Applicable for various shapes or brands.



Can be put on with one touch, and won't fall off when turned upside down.



ENDMILL HOUSE  
→ P.11

## TCA

Attaches to the tip of a tool holder.

## TCC

Attached by deforming its cap.



## TCB

Attaches directly to the tip of the cutting tool.



## TCA type

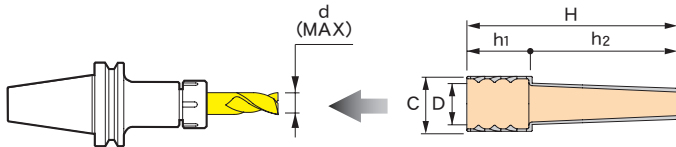

CODE(Master holder)	$\phi D$	$\phi C$	$\phi d$	H	h1	h2	Q'ty
TCA2022	20 ~ 22	29	8	100	30	70	10, 50, 100, 300, 500pcs. Please order by adding Q'ty to the end of the code. Ex. TCA2022-10
TCA2830	28 ~ 30	34	14	130	40	90	
TCA3436	34 ~ 36	41		135	45		
TCA4043	40 ~ 43	47	20	152	47	105	
TCA4650	46 ~ 50	54		167		120	



Distinguish size of cutter by Tool Cap colors

## Cap dispenser

Dispenser exclusively for storing TCA-type tool caps. Made of transparent acrylic resin, allowing you to confirm which caps are still in the dispenser.

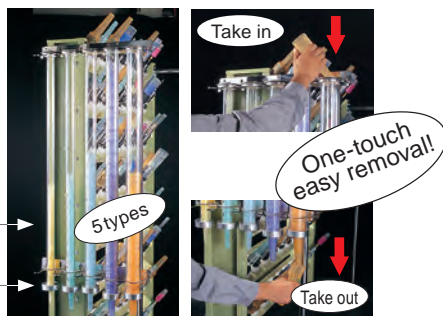

## Cap dispenser

CODE	Type	Q'ty
CAP2022	TCA2022	31pcs.
CAP2830	TCA2830	20pcs.
CAP3436	TCA3436	
CAP4043	TCA4043	22pcs.
CAP4650	TCA4650	

## Dedicated bracket

Five cap servers can be attached. Attach the bracket to a wall using bolts. Surface is metal plated.

CODE
SRV-01

## TCB type

Handles a broad range of sizes.

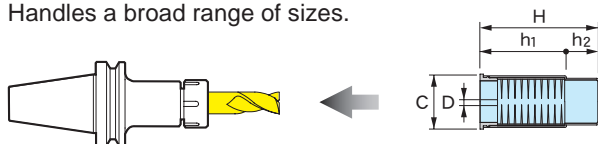

CODE(Master holder)	$\phi D$	$\phi C$	H	h1	h2	Q'ty
TCB0820	8~20	33	82	52	30	10, 50, 100, 300, 500pcs. Please order by adding Q'ty to the end of the code. Ex. TCB0820-10
TCB2042	20~42	54	102	62	40	

### Note

- The bristles of the brush may become deformed during use. If such deformation occurs, remove the brush and immerse it in hot water (60°C to 80°C). This should restore the deformed bristles to their original state.

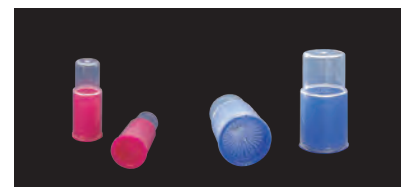

Distinguish size of cutter by Tool Cap colors

## TCC type

Simple and reasonably priced.  
For small size tool holders and cutting tools.

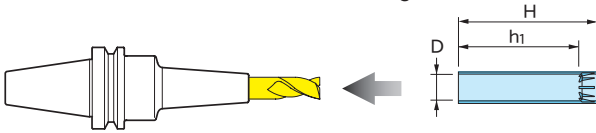

CODE	φD	h1	H	Q'ty
TCD03-50	3	—	25	50pcs.
TCD04-50	4	—	32	50pcs.
TCC0607-50	5.4~ 6.7	35	40	50pcs.
-100				100pcs.
-500				500pcs.
TCC0709-50	6.8~ 8.9	35	40	50pc.
-100				100pcs.
-500				500pcs.
TCC0911-50	8.9~10.9	65	70	50pcs.
-100				100pcs.
-500				500pcs.
TCC1113-50	10.9~13.4	65	70	50pcs.
-100				100pcs.
-500				500pcs.
TCC1418-25	13.8~17.8	100	110	25pcs.
-50				50pcs.
-250				250pcs.
TCC1822-25	17.8~22.4	100	110	25pcs.
-50				50pcs.
-250				250pcs.

CODE	φD	h1	H	Q'ty
TCC2228-25	22.3~28	135	150	25pcs.
-50				50pcs.
-250				250pcs.
TCC2836-10	28 ~36	130	150	10pcs.
-20				20pcs.
-50				50pcs.
-200				200pcs.
TCC3646-10	36.2~47.0	165	190	10pcs.
-20				20pcs.
-50				50pcs.
-200				200pcs.
TCC4760-10	46 ~60	160	190	10pcs.
-20				20pcs.
-50				50pcs.
-200				200pcs.

### Variety set

CODE	Q'ty
TCC-F	2 pieces per cutting tool cover size for TCC0607 to 4760 (Total of 20 pieces / set)



You can cut it to any desired length.

## Collet stand **PALETTE**

This pallet neatly houses collets.

- ▶ Uniquely designed by an industrial designer.
- ▶ Protects the collets from damage to maintain their accuracy.
- ▶ Both top side and back side are usable.
- ▶ Affixing labels allows easy storage by size.
- ▶ Has standard outer dimensions ensuring applicability to various types of drawers and shelves.
- ▶ Applicable regardless of manufacturer.

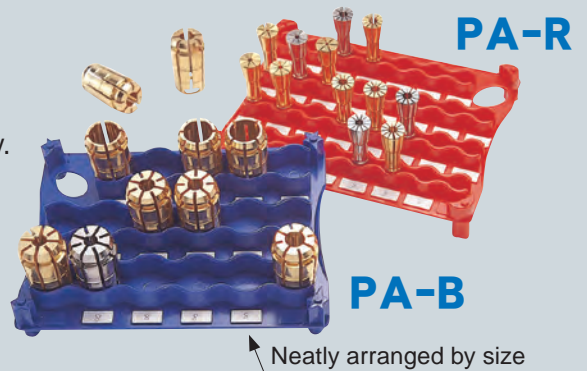

### PA-R

CODE	Q'ty
PA-R-1	1pc.
-5	5pcs.
-10	10pcs.

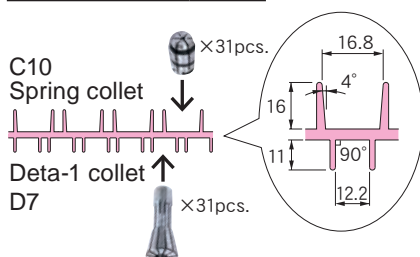
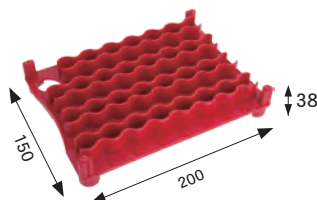

### PA-B

CODE	Q'ty
PA-B-1	1pc.
-5	5pcs.
-10	10pcs.

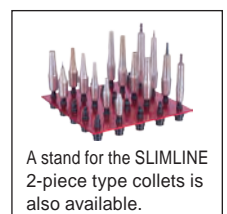
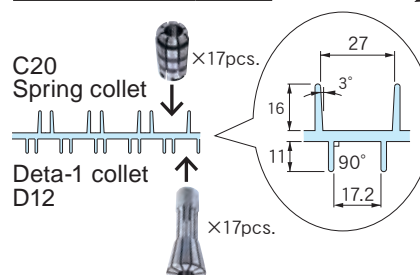
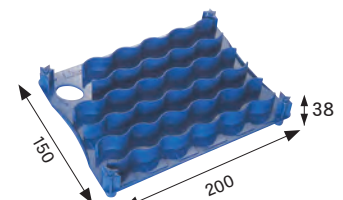

# TOOL HOLDER STORING CABINET

Compact Storage Box with Anti-Rust Treatment for tool holders.

▷ Orderly storing with name plate!



Name Plate

▷ A multi-hole base plate allows for a variety of tool holders using pins that can be freely changed and relocated.



Horizontal type



Vertical type

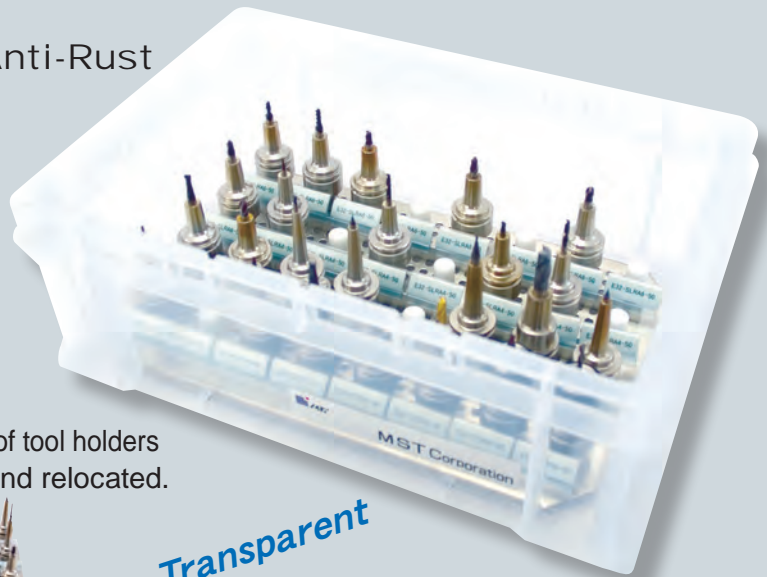

Transparent case!!

HBX

## Standard Set

CODE	Max. Q'ty	Container box	Pin	Q'ty	Shank type
HBX-A40	24	CN-150	HBX-PNE40	18pcs.	HSK-A40
-A50	15	-245	-PNE50	15pcs.	-A50
-E25	40	-150	-PNE25	32pcs.	-E25
-E32			-PNE32		-E32
-E40			-PNE40		-E40
-E50	15	-245	-PNE50	15pcs.	-E50
-F63	10				-F63
-15T	40	-150	-PN15T	16pcs.	15T(BROTHER)
-20T			-PN20T		RS20/20T(SUGINO)

### ■ Contents of set

- Base plate ●Container box ●Pin

### ■ Option

- Rail ●Name plate
- Lid for container box ●Eyenut

### ■ Note

- Knock-down type. A wrench (5mm) is required.

## Base plate

A multi-hole base plate allows for a variety of tool holders using pins that can be freely changed and relocated.

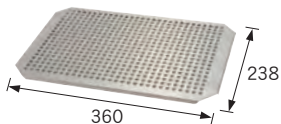

CODE
HBX-BP01

## Container box

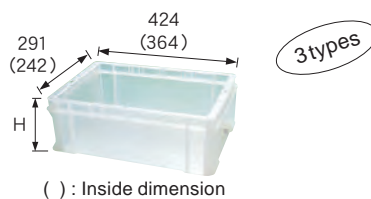

( ) : Inside dimension

CODE	H		Shank type
	Outside dimension	Inside dimension	
CN-103	103	88	-
-150	150	135	E25, 32, 40/15T/20T
-245	245	230	A50, E50, F63

## Pin

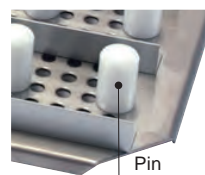

CODE	Q'ty	Size
HBX-PNE25	10pcs.	φ 13.5 × H20
-PNE32		φ 16.5 × H25
-PNE40	5pcs.	φ 20.5 × H29
-PNE50		φ 25.5 × H36
-PN15T		φ 26.5 × H54
-PN20T		φ 30.5 × H62

### ■ Std. Access.

- Mounting bolt (M6)

## Eyenut



CODE	Q'ty
HBX-ENM6	2pcs.

### ■ Std. Access.

- Mounting bolt (M6)

## Rail (for name plate)

Required for attaching name plate.

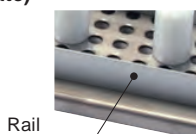

CODE	Q'ty	L	Note
HBX-R210	6pcs.	210	Vertical type
-R330	4pcs.	330	Horizontal type

### ■ Std. Access.

- Mounting bolt (M5)

## Name plate

Useful for organizing tools. Attaches easily to the rail.

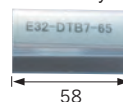

CODE	Q'ty
HBX-NP01	40pcs.

Freely cut to required overall length

## Lid for container box



CODE
CN-FT



Are you having trouble storing your cutting tools?

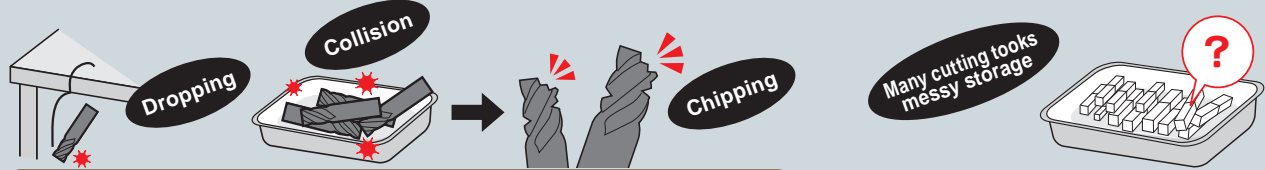

Cutting tool expenses increase due to cutting edge chipping. The required cutting tool cannot be found easily.

## Save cutting tool expenses and time with the optimum working environment.

- ▶ Cutting tool life is extended because the cutting edge is not dulled from striking other cutters.
- ▶ You can find the required cutting tool immediately.

Free combination of sizes.

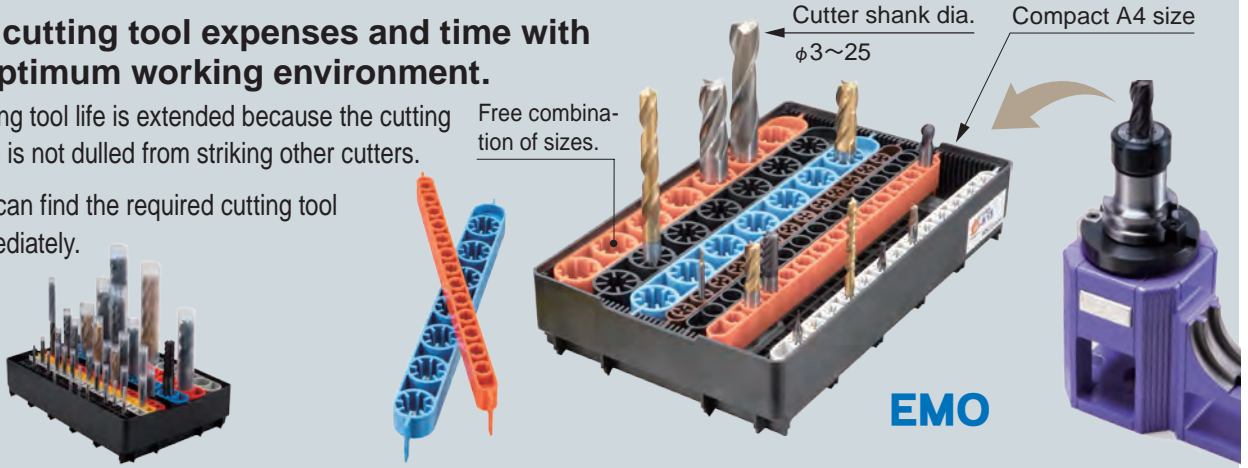

## Value set

This is a convenient value set that can be immediately used and handles tool shank diameters of 3 mm to 12 mm. (Stores 156 cutting tools)

CODE	Stand	Base	TOOL CAP	TOOL CAP storage box																																
EMO-SET-01	<table border="1"> <thead> <tr> <th>Cutter dia</th> <th>Q'ty</th> </tr> </thead> <tbody> <tr><td>φ 3</td><td>1pc.</td></tr> <tr><td>φ 4</td><td>2pcs.</td></tr> <tr><td>φ 6</td><td>3pcs.</td></tr> <tr><td>φ 8</td><td>2pcs.</td></tr> <tr><td>φ 10</td><td>2pcs.</td></tr> <tr><td>φ 12</td><td>2pcs.</td></tr> </tbody> </table>	Cutter dia	Q'ty	φ 3	1pc.	φ 4	2pcs.	φ 6	3pcs.	φ 8	2pcs.	φ 10	2pcs.	φ 12	2pcs.	<table border="1"> <thead> <tr> <th>Q'ty</th> </tr> </thead> <tbody> <tr><td>1pc.</td></tr> </tbody> </table>	Q'ty	1pc.	<table border="1"> <thead> <tr> <th>Cutter dia</th> <th>Q'ty</th> </tr> </thead> <tbody> <tr><td>φ 3</td><td>50pcs.</td></tr> <tr><td>φ 4</td><td>50pcs.</td></tr> <tr><td>φ 6</td><td>50pcs.</td></tr> <tr><td>φ 8</td><td>50pcs.</td></tr> <tr><td>φ 10</td><td>50pcs.</td></tr> <tr><td>φ 12</td><td>50pcs.</td></tr> </tbody> </table>	Cutter dia	Q'ty	φ 3	50pcs.	φ 4	50pcs.	φ 6	50pcs.	φ 8	50pcs.	φ 10	50pcs.	φ 12	50pcs.	<table border="1"> <thead> <tr> <th>Q'ty</th> </tr> </thead> <tbody> <tr><td>1pc.</td></tr> </tbody> </table>	Q'ty	1pc.
Cutter dia	Q'ty																																			
φ 3	1pc.																																			
φ 4	2pcs.																																			
φ 6	3pcs.																																			
φ 8	2pcs.																																			
φ 10	2pcs.																																			
φ 12	2pcs.																																			
Q'ty																																				
1pc.																																				
Cutter dia	Q'ty																																			
φ 3	50pcs.																																			
φ 4	50pcs.																																			
φ 6	50pcs.																																			
φ 8	50pcs.																																			
φ 10	50pcs.																																			
φ 12	50pcs.																																			
Q'ty																																				
1pc.																																				

φ 3...13 pcs. φ 4 ...26 pcs. φ 6 ...39 pcs.  
φ 8...26 pcs. φ 10...26 pcs. φ 12...26 pcs.

## Stand

Parts for storing and securing cutting tools. It is possible to identify the cutting tool size by color, and the cutting tool you need can be found at a glance. Use this stand inserting into the base.

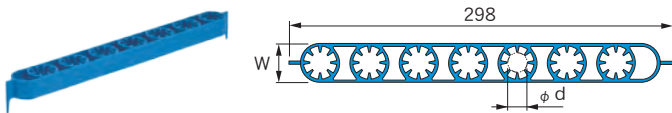

CODE	φ d	W	max. Q'ty	Color	Q'ty
EMO-STD 3-2	3	15 mm (1W)	13 pcs./cutting tools/stand	Black	2pcs.
-5	Black			5pcs.	
-STD 4-2	4			Brown	2pcs.
-5	Brown			5pcs.	
-STD 6-2	6			Gray	2pcs.
-5	Gray			5pcs.	
-STD 8-2	8			Yellow	2pcs.
-5	Yellow			5pcs.	
-STD10-2	10			Orange	2pcs.
-5	Orange			5pcs.	
-STD12-2	12	30 mm (2W)	7 pcs./cutting tools/stand	Black	2pcs.
-5	Black			5pcs.	
-STD16-2	16			Blue	2pcs.
-5	Blue			5pcs.	
-STD20-2	20			Orange	2pcs.
-5	Orange			5pcs.	
-STD25-2	25			Gray	2pcs.
-5	Gray	5pcs.			

## Base

Container for holding the stands. Stands can be arranged by changing the combination of stands freely.

CODE	Q'ty
EMO-BAS-1	1pc.
-3	3pcs.

- Note
- 12 rows for the stands of 3mm to 12mm diameter or 6 rows for the stands of 16mm to 25mm diameter.
- The left-right orientation of the stands can be set.

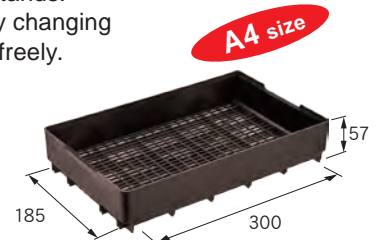

## Example of stand arrangement

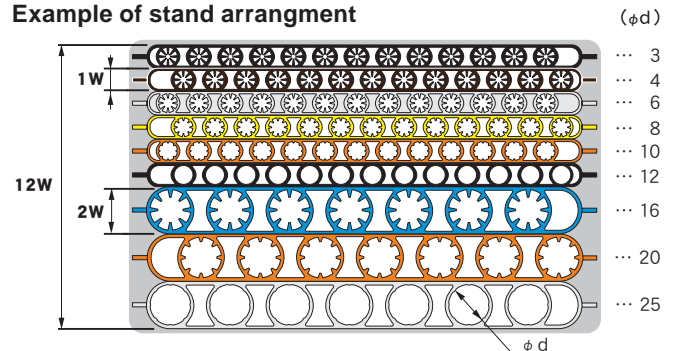

# For shrink-fit holders **Cleaning tools**

Be sure to clean holders before shrink-fitting!

## ▷ Brush type

Prevent decreased run-out accuracy by removing cutting chips and dirt from the internal bore.



When a cutting tool can't be inserted into the internal bore smoothly

## ▷ Rubber grinding stone type

To eliminate strong oxidized film and burned-in dust and oil that have been generated in the internal bores.



## Brush type

CODE	I.D
<b>AQC-BR -SET</b>	3 [1/8], 4 [3/16], 6 [1/4], 8 [5/16], 10 [3/8], 12 [1/2], 1 ea. 6 pieces in total
<b>-BR 3-5</b>	3 [1/8 ], 5 pcs.
<b>-BR 4-5</b>	4 [3/16], 5 pcs.
<b>-BR 6-5</b>	6 [1/4 ], 5 pcs.
<b>-BR 8-5</b>	8 [5/16], 5 pcs.
<b>-BR10-5</b>	10 [3/8 ], 5 pcs.
<b>-BR12-5</b>	12 [1/2 ], 5 pcs.

### ■ Caution

- Do not use when holder is hot.

## Rubber grinding stone type

### Standard set

CODE	Note
<b>CLT-GTA-01</b>	1 ea. of below model

### Parts

CODE	Name	I.D	Q'ty
<b>CLT-GTA-GP</b>	Grip	—	1 pc.
<b>CLT-GTA 3-5</b>	Rubber grind stone	3	5 pcs.
<b>-GTA 4-5</b>		4	5 pcs.
<b>-GTA 6-5</b>		6	5 pcs.
<b>-GTA 8-5</b>		8	5 pcs.
<b>-GTA10-5</b>		10	5 pcs.

# Water cooling kit for shrink-fit holders **Aqua Cool**

Cooling kit for cooling SLIMLINE holders after shrink fitting or removing

- ▷ Water-cooling kit for shrink-fit holders
- ▷ Prevents rusting and washes



## Standard Set

CODE	Note
<b>AQC-KIT-01</b>	1 ea. for model to the right

## Parts

CODE	Name	Note
<b>AQC-EK-01-2</b>	Special Liquid	2 ℓ of undiluted Solution, Use at a dilution ratio of 3%.
<b>-AT-01</b>	Aqua Tray	Drainer plate
<b>-AH-01</b>	Adapter Hanger	Hanger for lowering holders into liquid.
<b>CN -245</b>	Container Box	—
<b>-FT</b>	Lid for Container Box	—