

HSK-A125 TOOLING SYSTEM

焼ばめホルダ **スリムライン**
SHRINK-FIT HOLDER SLIMLINE



モノカーブ
MONO CURVE



モノ 3°
MONO 3°



2ピースタイプ
2 PIECE modular

テーパホルダ
TAPER
HOLDER



最高の切削能力を実現!
Delivering the maximum
cutting performance

5軸制御マシニングセンタ
MAGシリーズ
5-Axis Machining Centers
MAG series

T2



T4



牧野フライス製作所
Makino Milling Machine Co., Ltd.



MST corporation



HSK-A125 TOOLING SYSTEM

スタンダード
Standard

MST軽量ホルダ
MST's weight saving holder.

同じ重量の中実ホルダ
The solid core holder, which has same weight with a weight saving holder.

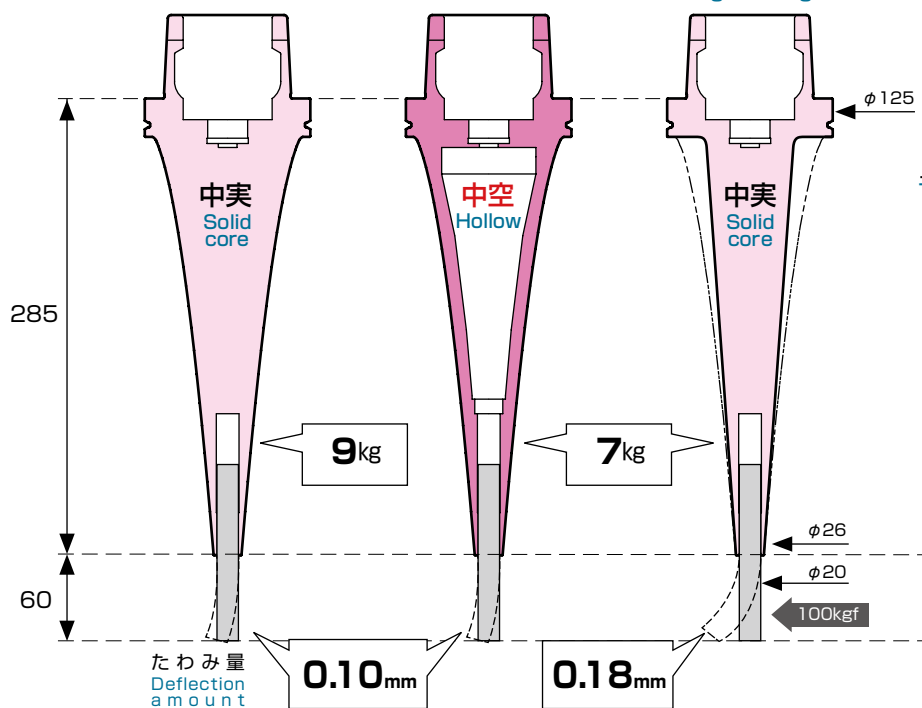

極限の中実形状
Extreme hollow configuration

軽い!
Lightweight

剛性UP!
Increase rigidity

焼ばめホルダ **スリムライン** SHRINK-FIT HOLDER SLIMLINE

テーパホルダ TAPER HOLDER

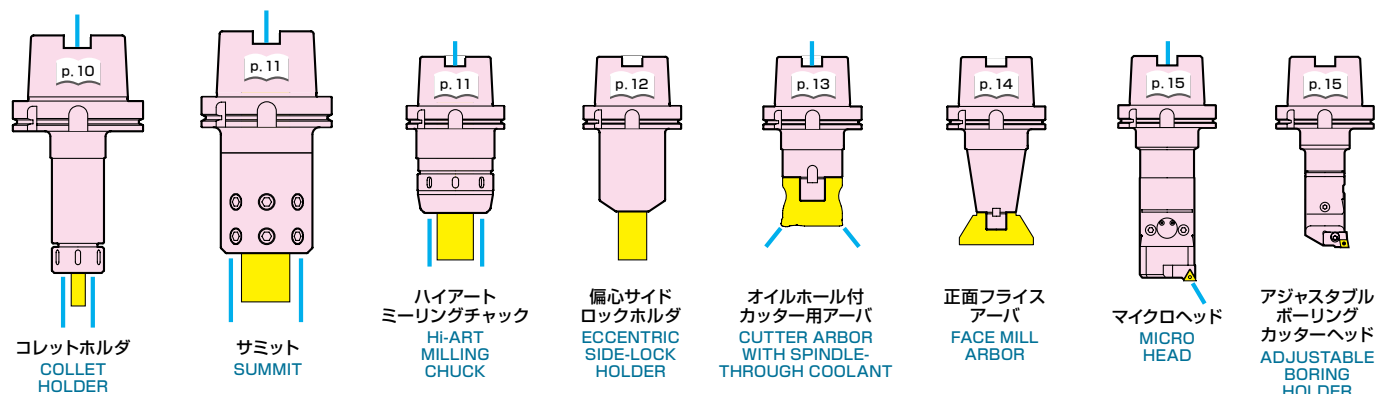
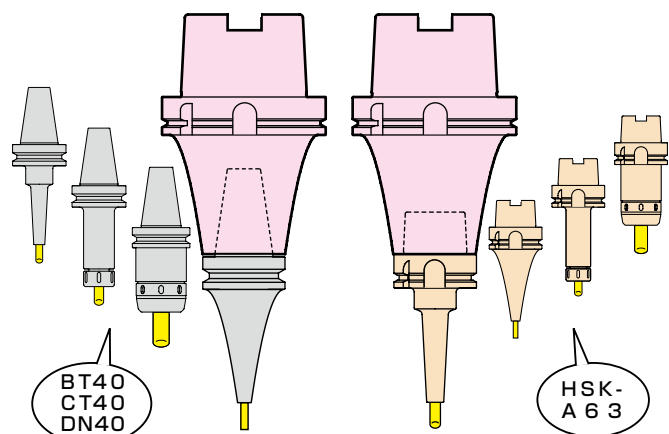
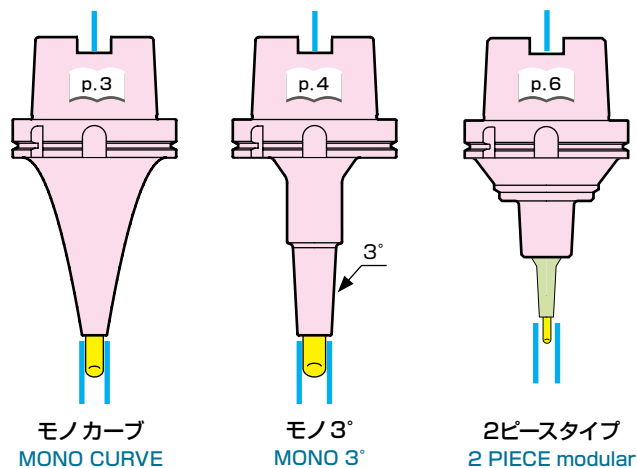

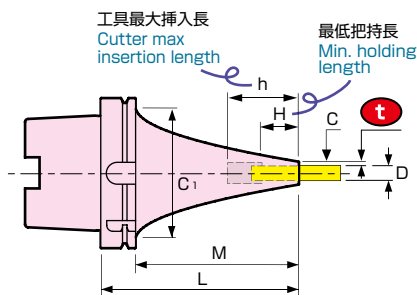

Metric

CODE	φD	φC	t	L	M	φC ₁	H	h	Kg	S
A125-SLSA12-165 cv	12	15	1.5	165	136	111	30	127	5.1	0.8
-225 cv				225	196			187	5.8	1.3
-285 cv				285	256			247	6.6	2.0
-345 cv				345	316			307	7.2	3.0
-SLRA12-165 cv	12	22	5	165	136	111	30	127	5.5	0.6
-225 cv				225	196			187	6.0	0.8
-285 cv				285	256			247	6.5	1.5
-SLFA12-165 cv	12	22	5	165	136	111	30	127	5.5	0.6
-225 cv				225	196			187	6.0	0.8
-285 cv				285	256			247	6.5	1.5
-SLSB16-165 cv	16	21	2.5	165	136	111	32	127	6.0	0.6
-225 cv				225	196			187	6.1	0.9
-285 cv				285	256			247	6.5	1.7
-345 cv				345	316			307	7.4	2.3
-SLSB20-165 cv	20	26	3	165	136	111	40	127	5.5	0.5
-225 cv				225	196			187	6.2	0.7
-285 cv				285	256			247	7.1	1.1
-345 cv				345	316			307	7.5	2.0

Inch

CODE	φD	φC	t	L	M	φC ₁	H	h	Kg	S
A125-SLSA1/2-165 cv	.5000	0.62	.06	6.50	5.35	4.37	1.18	5.00	5.0	0.8
-225 cv				8.86	7.72			7.36	5.9	1.3
-285 cv				11.22	10.08			9.72	6.7	2.1
-345 cv				13.58	12.44			12.21	7.6	3.1
-SLRA1/2-165 cv	.5000	.89	.20	6.50	5.35	4.37	1.18	5.00	5.4	0.6
-225 cv				8.86	7.72			7.36	6.2	0.8
-285 cv				11.22	10.08			9.72	6.6	1.5
-SLFA1/2-165 cv	.5000	.89	.20	6.50	5.35	4.37	1.18	5.00	5.4	0.6
-225 cv				8.86	7.72			7.36	6.2	0.8
-285 cv				11.22	10.08			9.72	6.6	1.5
-SLSB5/8-165 cv	.6250	.82	.10	6.50	5.35	4.37	1.26	5.00	5.8	0.6
-225 cv				8.86	7.72			7.36	6.3	0.9
-285 cv				11.22	10.08			9.72	6.8	1.7
-345 cv				13.58	12.44			12.21	8.0	2.3
-SLSB3/4-165 cv	.7500	.99	.12	6.50	5.35	4.37	1.50	5.00	5.4	0.5
-225 cv				8.86	7.72			7.36	6.8	0.7
-285 cv				11.22	10.08			9.72	7.0	1.3
-345 cv				13.58	12.44			12.21	8.2	2.0

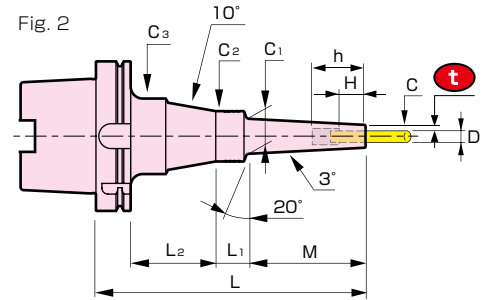
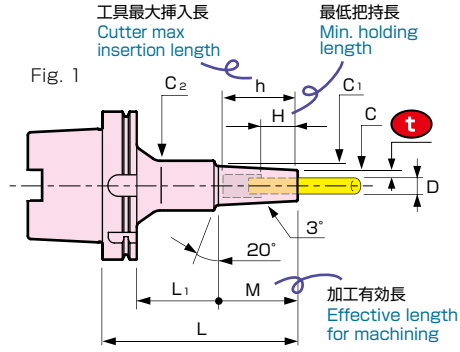
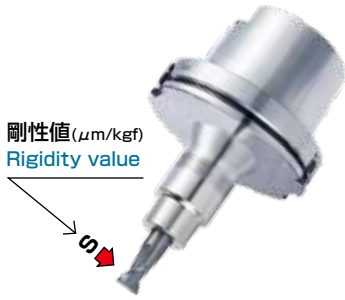

- 標準付属品
- 備考
- Standard accessories
- Note
- クーラントダクト
- バランス値は L=165のホルダが約50g・mm、L=345のホルダが約80g・mm となります。
- Coolant duct
- Imbalance value is approx. 50gr・mm with L=165mm holder and approx. 80gr・mm with L=345mm holder.



Metric

CODE	Fig.	φD	φC	t	L	M	L1	L2	φC1	φC2	φC3	H	h	Kg	S
A125-SLSB12-225-M 97	2	12	19	3.5	225	97	28	71	29.2	42	63	30	187	4.8	2.8
-M127	1				127	69	-		32.3		-			4.4	3.8
-M157					157	39			35.5						4.1
-255-M127	2				255	127	28	71	32.3		63		217	4.9	3.7
-M157	1				157	69	-		35.5		-			4.6	4.7
-285-M157	2				285		28	71			63		247	5.1	
-SLRB12-90-M 22	1		26	7	90	22	39	-	28.3		-		52	3.9	0.4
-120-M 22					120		69						82	4.1	0.5
-150-M 22	2				150		28	71			63		112	4.6	
-SLFB12-90-M 22	1				90		39	-			-		52	3.9	0.4
-120-M 22					120		69						82	4.1	0.5
-150-M 22	2				150		28	71			63		112	4.6	
-SLSB16-225-M 97	2	16	24	4	225	97	28	71	34.2	42	63	32	187	4.9	2.1
-M127	1				127	69	-		37.3	53	-			4.8	2.3
-M157					157	39			40.5					4.7	2.6
-255-M127	2				255	127	28	71	37.3		70		217	5.5	2.3
-M157	1				157	69	-		40.5		-			5.1	2.9
-285-M157	2				285		28	71			70		247	5.7	
-SLRB16-90-M 22	1		32	8	90	22	39	-	34.3	42	-		52	3.9	0.3
-120-M 22					120		69						82	4.1	0.5
-150-M 22	2				150		28	71			63		112	4.6	
-SLFB16-90-M 22	1				90		39	-			-		52	3.9	0.3
-120-M 22					120		69						82	4.1	0.5
-150-M 22	2				150		28	71			63		112	4.6	
-SLSB20-225-M 97	2	20	29	4.5	225	97	28	71	39.2	53	70	40	187	5.4	1.3
-M127	1				127	69	-		42.3		-			5.0	1.7
-M157					157	39			45.5					4.9	1.9
-255-M127	2				255	127	28	71	42.3		70		217	5.6	1.8
-M157	1				157	69	-		45.5		-			5.3	2.2
-285-M157	2				285		28	71			70		247	5.9	
-SLRB20-110-M 42	1		38	9	110	42	39	-	42.4		-		72	4.2	0.3
-135-M 67					135	67			45.0				97	4.5	0.5
-SLFB20-110-M 42					110	42			42.4				72	4.2	0.3
-135-M 67					135	67			45.0				97	4.5	0.5
-SLRB25-110-M 42	1	20	45	10	110	42	39	-	49.4	53	-	45	72	4.3	0.3
-SLFB25-110-M 42															

Inch

CODE	Fig.	φD	φC	t	L	M	L ₁	L ₂	φC ₁	φC ₂	φC ₃	H	h	 Kg	 S			
A125-SLSB1/2-225-M 97	2	.5000	.78	.14	8.86	3.82	1.10	2.80	1.15	1.65	2.48	1.18	7.36	4.8	2.7			
-M127	1					5.00	2.72	-	1.27	-	-			4.4	3.6			
-M157	1					6.18	1.54	-	1.40	-	-			3.9	-			
-255-M127	2				10.04	5.00	1.10	2.80	1.27	-	2.48	8.54	4.9	3.6				
-M157	1				6.18	2.72	-	1.40	-	-	4.6	4.6						
-285-M157	2				11.22	-	1.10	2.80	-	-	2.48	9.72	5.1	4.5				
-SLRB1/2- 90-M 22	1				1.05	.28	3.54	.87	1.54	-	1.14	-	2.05	3.9	0.4			
-120-M 22	1				4.72	-	2.72	-	-	-	3.23	4.1	0.5					
-150-M 22	2				5.91	1.10	2.80	-	-	-	2.48	4.41	4.6					
-SLFB1/2- 90-M 22	1				3.54	1.54	-	-	-	-	2.05	3.9	0.4					
-120-M 22	1				4.72	2.72	-	-	-	-	3.23	4.1	0.5					
-150-M 22	2				5.91	1.10	2.80	-	-	-	2.48	4.41	4.6					
-SLSB5/8-225-M 97	2	.6250	.94	.16	8.86	3.82	1.10	2.80	1.35	1.65	2.48	1.26	7.36	4.9	2.1			
-M127	1					5.00	2.72	-	1.47	2.09	-			4.8	2.3			
-M157	1					6.18	1.54	-	1.59	-	-			4.7	2.6			
-255-M127	2				10.04	5.00	1.10	2.80	1.47	-	2.76	8.54	5.5	2.3				
-M157	1				6.18	2.72	-	1.59	-	-	5.1	2.9						
-285-M157	2				11.22	-	1.10	2.80	-	-	2.76	9.72	5.7	-				
-SLRB5/8- 90-M 22	1				1.26	.32	3.54	.87	1.54	-	1.35	1.65	-	2.05	3.9	0.3		
-120-M 22	1				4.72	2.72	-	-	-	-	3.23	4.1	0.5					
-150-M 22	2				5.91	1.10	2.80	-	-	-	2.48	4.41	4.6					
-SLFB5/8- 90-M 22	1				3.54	1.54	-	-	-	-	2.05	3.9	0.3					
-120-M 22	1				4.72	2.72	-	-	-	-	3.23	4.1	0.5					
-150-M 22	2				5.91	1.10	2.80	-	-	-	2.48	4.41	4.6					
-SLSB3/4-225-M 97	2	.7500	1.10	.18	8.86	3.82	1.10	2.80	1.54	2.09	2.76	1.50	7.36	5.4	1.4			
-M127	1					5.00	2.72	-	1.67	-	-			4.9	1.8			
-M157	1					6.18	1.54	-	1.79	-	-			4.8	2.0			
-255-M127	2				10.04	5.00	1.10	2.80	1.66	-	2.76	8.54	5.6	1.8				
-M157	1				6.18	2.72	-	1.79	-	-	5.2	2.3						
-285-M157	2				11.22	-	1.10	2.80	-	-	2.76	9.72	5.8	-				
-SLRB3/4-110-M 42	1				1.46	.35	4.33	1.65	1.54	-	1.63	2.12	-	2.83	4.2	0.3		
-135-M 67	1				5.31	2.64	-	-	-	-	3.82	4.4	0.5					
-SLFB3/4-110-M 42	1				4.33	1.65	-	-	-	-	2.83	4.2	0.3					
-135-M 67	1				5.31	2.64	-	-	-	-	3.82	4.4	0.5					
-SLRB1" -110-M 42	1				1.0000	1.79	.39	4.33	1.65	1.54	-	1.96	2.12	-	1.77	2.83	4.3	0.3
-SLFB1" -110-M 42	1				-	-	-	-	-	-	-	-	-	-	-	-	-	-

- 標準付属品 ●クーラントダクト
- 備考 ●バランス値は L=90のホルダが約40g・mm、L=285のホルダが約70g・mm となります。
- Standard accessories ●Coolant duct
- Note ●Imbalance value is approx. 40gr・mm with L=90mm holder and approx. 70gr・mm with L=285mm holder.



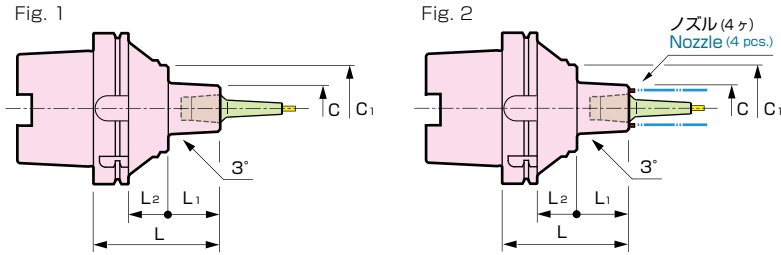

ノズルスルー
Coolant-through
nozzle

CODE	Fig.	ϕC	L	L1	L2	$\phi C1$	Kg	g/mm
A125-SLK12-105	1	38	105	43	33	72	5.1	36.1
-165			165	103			5.8	36.8
-105F	2	41	105	43			5.1	36.1
-135F			135	73			5.5	36.5

- オプション
- 標準付属品
- Option
- Standard accessories
- スリムラインコレット
- クーラントダクト
- SLIMLINE collet
- Coolant duct
- レンチ
- ノズル
- Wrench
- Nozzle

スリムラインコレット

SLIMLINE collet



剛性値 ($\mu\text{m}/\text{kgf}$)
Rigidity value

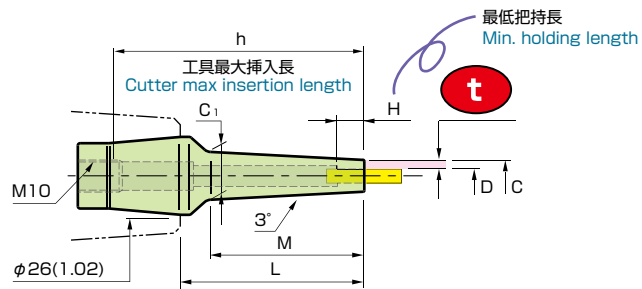

Metric

スリム型

Slim type

CODE	ϕD	ϕC	t	L	M	$\phi C1$	H	h	S	Kg
CS12- 3- 35	3	6	1.5	35	22	8.4	10	60	4.8	0.2
- 55				55	42	10.5	80	9.5		
- 80				80	67	13.1	105	15.0		
-110				110	97	16.2	135	20.6		
-3.175- 35	3.175	6.175	1.5	35	22	8.5	10	60	4.6	0.2
- 55				55	42	10.6	80	9.0		
- 80				80	67	13.2	105	14.3		
-110				110	97	16.4	135	19.7		
- 4- 35	4	7	1.5	35	22	9.4	12	60	3.8	0.2
- 55				55	42	11.5	80	7.5		
- 80				80	67	14.1	105	11.9		
-110				110	97	17.2	135	16.6		
- 5- 35	5	8	1.5	35	22	10.4	15	60	3.0	0.2
- 55				55	42	12.5	80	6.0		
- 80				80	67	15.1	105	9.7		
-110				110	97	18.2	135	13.6		
- 6- 35	6	9	1.5	35	22	11.4	18	60	2.4	0.2
- 55				55	42	13.5	80	4.9		
- 80				80	67	16.1	105	8.0		
-110				110	97	19.2	135	11.4		
- 7- 35	7	10	1.5	35	22	12.4	20	60	2.0	0.2
- 55				55	42	14.5	80	4.1		
- 80				80	67	17.1	105	6.8		
-110				110	97	20.2	135	9.7		

CODE	ϕD	ϕC	t	L	M	$\phi C1$	H	h	S	Kg
CS12- 8- 35	8	11	1.5	35	22	13.4	25	60	1.6	0.2
- 55				55	42	15.5	80	3.4		
- 80				80	67	18.1	105	5.6		
-110				110	97	21.2	135	8.2		
- 9- 35	9	12	1.5	35	22	14.4	30	60	1.4	0.2
- 55				55	42	16.5	80	2.9		
- 80				80	67	19.1	105	4.8		
-110				110	97	22.2	135	7.1		
-10- 35	10	13	1.5	35	22	15.4	30	60	1.3	0.2
- 55				55	42	17.5	80	2.5		
- 80				80	67	20.1	105	4.3		
-110				110	97	23.2	135	6.2		
-11- 35	11	14	1.5	35	22	16.4	30	60	1.1	0.2
- 55				55	42	18.5	80	2.3		
- 80				80	67	21.1	105	3.8		
-110				110	97	24.2	135	5.6		
-12- 35	12	15	1.5	35	22	17.4	30	60	1.0	0.2
- 55				55	42	19.5	80	2.1		
- 80				80	67	22.1	105	3.5		
-110				110	-	-	135	5.0		



レギュラー型

Regular type

CODE	φD	φC	φC ₁	t	L	M	H	h	S	kg
CR12- 3-35	3	7.5	9.9	2.25	35	22	10	60	2.9	0.2
-55			12		55	42		80	5.5	
-80			14.6		80	67		105	8.9	
- 4-35	4	10	12.4	3	35	22	12	60	1.7	0.2
-55			14.5		55	42		80	3.1	
-80			17.1		80	67		105	5.1	
- 6-35	6	12	14.4	3	35	22	18	60	1.3	0.2
-55			16.5		55	42		80	2.4	
-80			19.1		80	67		105	3.9	
- 8-35	8	14	16.4	3	35	22	25	60	1.1	0.2
-55			18.5		55	42		80	1.9	
-80			21.1		80	67		105	3.1	0.3
-10-35	10	16	18.4	3	35	22	30	60	0.9	0.2
-55			20.5		55	42			1.6	
-80			23.1		80	67			2.6	0.3
-12-35	12	20	22.4	4	35	22	30	60	0.7	0.2
-55			24.5		55	42			1.1	
-80			25.5		80	-			1.9	0.3

フラッシュ型

Flush type

CODE	φD	φC	φC ₁	t	L	M	H	h	S	kg
CF12- 3-35	3	9.5	11.9	3.25	35	22	10	60	1.9	0.2
-55			14		55	42		80	3.3	
-80			16.6		80	67		105	5.3	
- 4-35	4	12	14.4	4	35	22	12	60	1.3	0.2
-55			16.5		55	42		80	2.2	
-80			19.1		80	67		105	3.4	
- 6-35	6	14	16.4	4	35	22	18	60	1.0	0.2
-55			18.5		55	42		80	1.7	
-80			21.1		80	67		105	2.7	0.3
- 8-35	8	16	18.4	4	35	22	25	65	0.9	0.2
-55			20.5		55	42		85	1.4	
-80			23.1		80	67		110	2.3	0.3
-10-35	10	18	20.4	4	35	22	30	60	0.7	0.2
-55			22.5		55	42			1.1	
-80			-		80	-			1.9	0.3
-12-35	12	20	22.4	4	35	22	30	60	0.7	0.2
-55			24.5		55	42			1.1	
-80			-		80	-			1.9	0.3

Inch

スリム型

Slim type

CODE	φD	φC	φC ₁	t	L	M	H	h	S
CS12-1/ 8- 80	.1250	.24	.52	.059	3.15	2.64	.38	4.33	14.0
-110			.64		4.33	3.82		5.51	19.3
-3/16- 80	.1875	.31	.58		3.15	2.64	.58	4.33	10.3
-110			.71		4.33	3.82		5.51	14.2
-1/ 4- 80	.2500	.37	.64		3.15	2.64	.70	4.33	7.4
-110			.77		4.33	3.82		5.51	10.5
-5/16- 80	.3125	.43	.71		3.15	2.64	.98	4.33	5.6
-110			.83		4.33	3.82		5.51	8.1
-3/ 8- 80	.3750	.49	.77		3.15	2.64	1.18	2.36	4.4
-110			.89		4.33	3.82			6.4
-1/ 2- 80	.5000	.62	-		3.15	2.64			3.1
-110			-		4.33	3.82			4.8

レンチ
Wrench

CODE
W-135

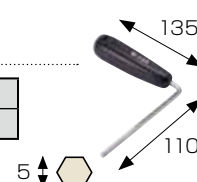

本体とスリムラインコレットの締付けに使用します。
Used for clamping of master holder and SLIMLINE collet.

コレットスタンド
Collet stand

CODE
SDK-01

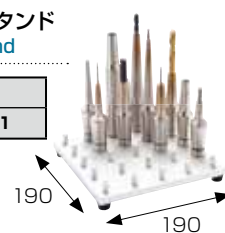

スリムラインコレットをコンパクトに整理できます。冷却効果に優れたアルミ製で25本まで収納可能です。

For compact storage of SLIMLINE collets. Made of aluminum, assuring superior cooling for a maximum of 25 collets.

ノズル
Nozzle

CODE	数量 Q'ty
NOZ-M4-12	12
-60	60

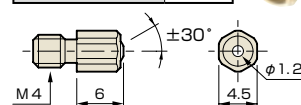

本体1体につき4ヶ必要です。
Four nozzles are required for each main body.



ノズルスルー
Coolant-through nozzle

レギュラー型

Regular type

CODE	φD	φC	φC ₁	t	L	M	H	h	S
CR12-1/ 8- 55	.1250	.36	.53	.089	2.17	1.65	.38	3.35	3.5
-3/16- 55	.1875	.42	.60	.119			.46		2.7
-1/ 4- 55	.2500	.49	.66				.70		2.2
-5/16- 55	.3125	.55	.72				.98		1.9
-3/ 8- 55	.3750	.61	.78				1.18	2.36	1.6
-1/ 2- 35	.5000	.81	.91	.157	1.38	.87			0.6
- 55			-		2.17	1.99			1.1



フラッシュ型

Flush type

CODE	φD	φC	φC ₁	t	L	M	H	h	S
CF12-1/ 8- 55	.1250	.38	.55	.128	2.17	1.65	.39	3.35	3.1
-3/16- 55	.1875	.50	.68	.157			.55		1.9
-1/ 4- 55	.2500	.56	.74				.71		1.6
-3/ 8- 55	.3750	.69	.86				1.18		1.3
-1/ 2- 55	.5000	.81	-			1.99			1.1

焼ばめ装置

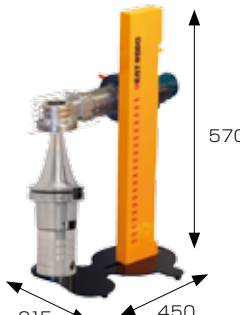

SHRINK-FIT HEATER

<p>ヒートロボBaby3000S HEAT ROBO BABY 3000S</p> <p>70 秒 sec. 10 分 min. CE 工具径φ6 エアー冷却 230EU Cutter dia Air cooling</p> <p>温風式 Hot air heater</p>  <p>570 215 450</p> <p>HRB-03S (200V-3000W) -03S-230NA / EU / AS (230V-3000W)</p>	<p>ヒートロボ電磁5000 HEAT ROBO DENJI 5000</p> <p>18 秒 sec. 1 分 min. CE 工具径φ6 エアー冷却 Cutter dia Air cooling</p> <p>電磁誘導 加熱方式 Electro-magnetic induction heater</p>  <p>740 370 510</p> <p>HRD-02 (200V-5000W)</p>
---	--

NA = アメリカ仕様, EU = ヨーロッパ仕様, AS = アジア仕様 NA = For America, EU = For Europe, AS = For Asia.

A125 シャンク専用アダプタ A125 exclusive use adaptor

CODE
BAA-02

スリムラインコレット用セット治具 Setup jigs for SLIMLINE collet

スリムラインコレットを焼ばめする際必要です。焼ばめ装置にセット、位置決めする治具です。
It requires for SLIMLINE Collet shrinking operation. It uses on the shrinking device to make a positioning.

CODE
ADH-SLK

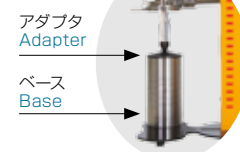

CODE
BAA-01

アダプタ Adapter
ベース Base

着脱ストッパー

Cutter Stopper

ホルダの焼ばめ・焼はずし時に、工具のストッパーとして利用します。
Used as a stopper in the holder hole when shrink fitting or removing a cutting tool.

HSB (板スプリング型)

(Plate spring type)

CODE	φD
HSB-D	3, 3.175, 4, 5, 6, 7, 8, 9, 10, 11, 12, 16, 20, 25 1/8, 3/16, 1/4, 5/16, 3/8, 1/2, 5/8, 3/4, 1"

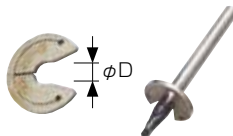

ストッパープライヤー

Stopper pliers

CODE
SPY-01





HSB

HSA (コイルスプリング型)

(Coil spring type)

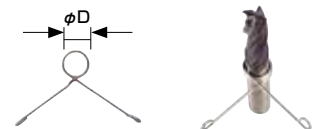
CODE	φD	入数 (1セット) Qty (1 set)
HSA-D	3, 3.175, 4, 5, 6, 7, 8, 9, 10, 11, 12, 16, 20, 25 1/8, 3/16, 1/4, 5/16, 3/8, 1/2, 5/8, 3/4, 1"	同サイズ10ヶ Contains 10 pcs. in each size
-F	3, 4, 5, 6, 7, 8, 9, 10, 11, 12	各1ヶ 1ea.
-EF	3, 4, 5, 6, 8, 10, 12, 16, 20, 25	各1ヶ 1ea.



注 意 : ヒートロボ電磁5000では使用できません。
Caution : Cannot be used with HEAT ROBO DENJI 5000.

便利なオプション

Useful optional accessories

刃物プライヤー Cutter pliers

CODE
HPY-01



刃物アジャスター Cutter adjuster

工具の突出し長さ・挿入長を設定できます。
Allows you to set the overhang of a cutting tool or align the lengths of several cutting tools.

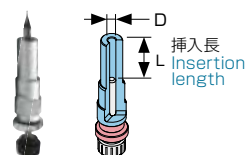

CODE	φD	L
HAJ- 3	3	10~ 30
- 3.175	3.175	
- 4	4	13~ 30
- 6	6	19~ 45
- 8	8	25~ 55
-10	10	31~ 70
-12	12	31~ 85
-16	16	33~ 90
-20	20	41~100
-25	25	46~100

テーパホルダ

TAPER HOLDER

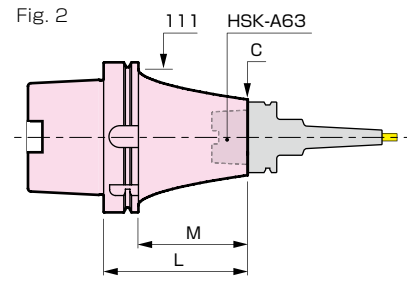
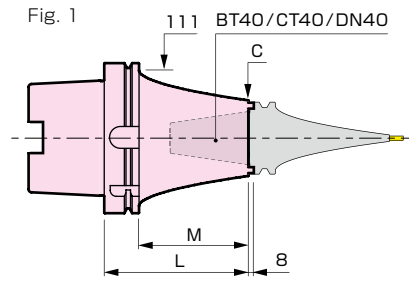

CODE	Fig.	ϕC	L	M	Kg
A125-TS-T40-110	1	65	110	81	2.9
-195			195	166	4.8
-A63-110	2	63	110	81	3.0
-195			195	166	4.5

- 標準付属品 ●クーラントダクト
- Standard ●Coolant duct accessories

TOOLING SYSTEM



SHRINK-FIT HOLDER
SLIMLINE



これらのカタログよりお選びください
Please select from these catalogues.

コレットホルダ

COLLET HOLDER

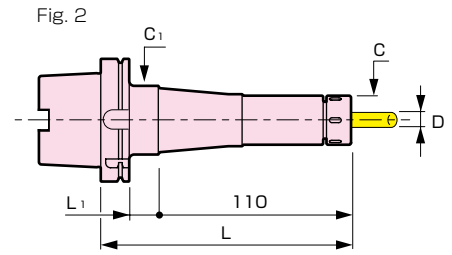
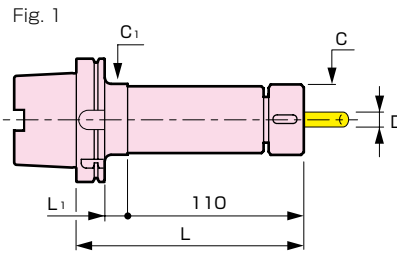

CODE	Fig.	ϕD	ϕC	L	L1	$\phi C1$	Kg
A125-CTH20-165	1	5.8 ~ 20	50	165	26	53	5.0
-195				195	56		5.4
-255				2	255		116
-315	315	176	80		7.4		
-CTH25-165	1	5.8 ~ 25	62	165	26	63	5.8
-195				195	56		6.3
-255				2	255		116
-315	315	176	85		9.0		

- オプション
 - スプリングコレット ●スパナ ●アジャスタブルトルクレンチ ●スキマナット
- 標準付属品
 - 丸ナット(NUA-CTH) ●クーラントダクト
- 備考
 - バランス値は L=165のホルダが約50g・mm、L=315のホルダが約100g・mm となります。
- Option
 - Spring collet ●Spanner ●Adjustable torque wrench ●Sukima nut
- Standard accessories
 - Nut(NUA-CTH) ●Coolant duct
- Note
 - Imbalance value is approx. 50gr・mm with L=165mm holder and approx. 100gr・mm with L=315mm holder.

スプリングコレット

Spring collet

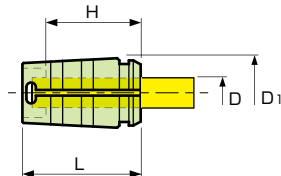

振れ精度
Runout accuracy

5 μ m

※コレット単体の精度
Accuracy of collet alone

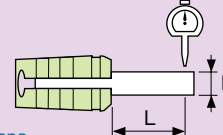

D	L
~ 10	4 × D
10.2 ~ 20	40
20.5 ~ 25	60

コード例
Ex. C10- ϕ 6-P

CODE	ϕD	適応本体 Holder type	縮り代 Collapsibility	L	$\phi D1$	H (工具最大挿入長 Cutter max insertion length)					
C20-D-P	6	CTH20	0.2	50	29.5	D= 6 ~ 9.8 → 29					
	8					10 ~ 15.8 → 33					
	10					16 ~ 20 → 40					
	12										
	14										
	16										
	18										
	20										
	C25-D-P					6	CTH25	0.2	68	36.5	D= 6 ~ 8 → 35
						10					10 ~ 15 → 46
16		15.5 ~ 20 → 54									
20		20.5 ~ 25 → 57									
22											
24											
25											

スパナ Spanner

CODE	ホルダ型式 Holder type	締付トルク Tightening torque
FC-50	CTH20	120N・m
-62	CTH25	150N・m



アジャスタブルトルクレンチ Adjustable torque wrench

ナットの締付トルクを適正に調節できます。
The nut-tightening torque can be adjusted more properly.

トルクレンチ用スパナ Spanner for torque wrench	アジャスタブルトルクレンチ Adjustable torque wrench	ホルダ型式 Holder type
FC-50AW	AW-2	CTH20



コレット抜き Collet remover

コレットの取はずしが簡単にできます。
The collet can be attached/detached with ease.

CODE	ホルダ型式 Holder type
C20-RM	C20



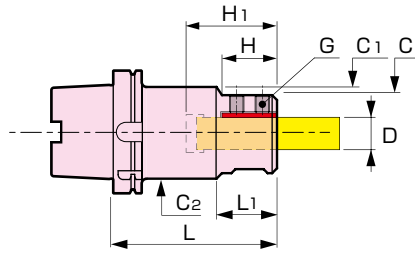

ノズルスルー
Coolant-through
nozzle

レンチ

Wrench

CODE	ホルダ型式 Holder Q'ty
W-206	SLZ25
-308	SLZ32 SLZ42



ノズル

Nozzle

CODE	数量 Q'ty
NOZ-M6-12	12
-20	20



- 標準付属品
- 取付け用レンチ
- Standard Accessories
- Wrench for attachment

CODE	φD	φC	L	L1	φC1	φC2	H	H1	G	Kg
A125-SLZ25-120	25	66	120	45	75	80	55	82	4-M12	5.7
-180			180							7.1
-SLZ32-150	32	88	150	96	90	-	85	112	6-M16	8.2
-210			210							9.7
-SLZ42-150	42	98	150	100	-	-	80	112	-	9.0
-210			210							10.7

- オプション ● レンチ ● ノズル
- 標準付属品 ● クーラントダクト
- 注意事項 ● 専用締付けレンチを使用しない場合、柄の長さが30cm(M16)以上、20cm(M12)以上のレンチで確実に締付け下さい。
- 備考 ● ドライブキー溝とセットボルトGは同位相です。
- Option ● Wrench ● Nozzle
- Standard accessories ● Coolant duct
- Caution ● If the dedicated wrench is not used, use a wrench with a minimum handle length of 30 cm for the M16 or 20 cm for the M12.
- Note ● A drive key groove and set screw, G are in same alignment.

ハイアートミーリングチャック

Hi-ART MILLING CHUCK

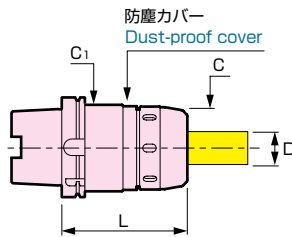

ノズルスルー
Coolant-through
nozzle

- オプション ● ストレートコレット ● エジェクトフック付スパナ
- ノズル
- 標準付属品 ● クーラントダクト
- 備考 ● クーラントスルー【ノズルスルー】をご利用の場合、ノズル・Fタイプストレートコレットが必要となります。
- Option ● Straight collet ● Adjust screw ● Nozzle
- Standard accessories ● Coolant duct
- Note ● The nozzle and straight collet (F type) are required for using through spindle coolant(Coolant-through nozzle).

CODE	φD	φC	L	φC1	工具挿入長 Cutter insertion length	Kg	許容回転数 (min ⁻¹) Allowable spindle rotation
A125-ART32-135	32	82	135	85	97	6.5	5,000
-195			195		8.0		
-ART42-135	42	97	135	100	97	7.5	3,000
-195			195		9.3		

ストレートコレット

Straight collet

スパナ

Spanner

標準 type
Standard type



F type

ノズル用切り欠き
Notch for nozzle

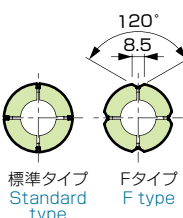
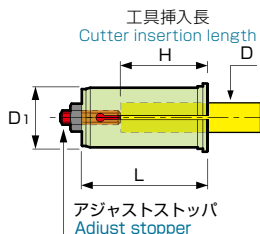
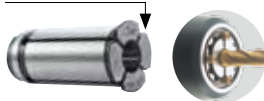

CODE		φD	適応本体 Holder type	L	φD1	H
標準 type Standard type	F type					
S32- 6	S32- 6F	6	ART32	75	32	30~68
- 8	- 8F	8				40~68
-10	-10F	10				50~68
-12	-12F	12				
-16	-16F	16				
-20	-20F	20				
S42- 6	S42- 6F	6	ART42	80	42	35~73
- 8	- 8F	8				45~73
-10	-10F	10				
-12	-12F	12				
-16	-16F	16				
-20	-20F	20				
-25	-25F	25				
-32	-32F	32				

CODE	適応本体 Holder type	締付けトルク Tightening torque
FM-82	ART32	70N·m
-97	ART42	



ストレートコレットの取りはずしもできます。
It can use for removing a straight collet.

偏心サイドロックホルダ

ECCENTRIC SIDE-LOCK HOLDER



Fig. 1

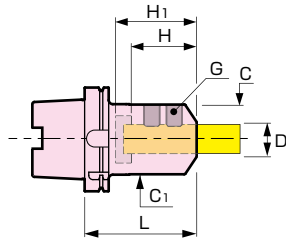
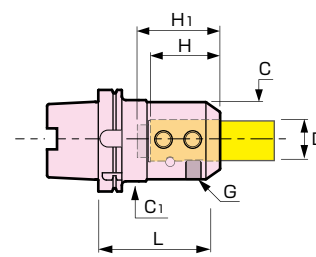

Fig. 2



Metric

CODE	Fig.	ϕD	ϕC	L	ϕC_1	H	H ₁	G	Kg	推奨締付トルク(N·m) Recommended tightening torque
A125-SLC16 -135	1	16	50	135	53	48	97	M14	4.7	5 ~ 6
				195			157			
-SLC20 -135		20	62	135	63	50	97	M16	5.4	10 ~ 13
				195			157			
-SLC25 -135		25	71	135	80	74	97	2-M18	6.1	
				195			157			
-SLC32 -135		32	84	135	85	79	97	2-M20	6.9	13 ~ 16
				195			157			
-SLC40 -150		40	92	150	100	94	112		8.0	
				210			172			
-SLC42 -150		42		150			112		8.0	
				210			172			
-SL 50.8-150	2	50.8	95	150		75	80	3-M20	8.0	
				210						

Inch

CODE	Fig.	ϕD	ϕC	L	C ₁	H	H ₁	G	Kg	推奨締付トルク(N·m) Recommended tightening torque
A125-SLC 5/8 -135	1	.6250	1.97	5.31	2.09	1.89	3.82	9/16-12	4.7	5~6
				7.68			6.18			
-SLC 3/4 -135		.7500	2.44	5.31	2.48	1.97	3.82	5/ 8-11	5.4	10~13
				7.68			6.18			
-SLC1" -135		1.0000	2.80	5.31	3.15	2.91	3.82	3/ 4-10	6.1	
				7.68			6.18			
-SLC1"1/4 -135		1.2500	3.31	5.31	3.35	3.11	3.82		6.9	13~16
				7.68			6.18			
-SLC1"1/2 -150		1.5000	3.62	5.91	3.94	3.70	4.41		8.0	
				8.27			6.77			

- 標準付属品 ●六角レンチ ●クーラントダクト
- 備考 ●使用する工具のシャンクには締め付け用の切り欠きが必要です。
- エンドミル切り欠き寸法表をご参照ください。
- ドライブキー溝とセットボルトGは同位相です。
- ピンロック式サイドロックホルダも製作いたします。
- Option ●Allen wrench ●Coolant duct
- The weldon shank is required for clamping.
- Refer to the weldon shank dimension table.
- A drive key groove and set screw, G are in same alignment.
- Pin lock type set screw holder available on request.

エンドミル切欠き寸法表 JIS B 4005 Weldon shank dimension table. JIS B 4005

ϕd (h6)	L	L ₁	L ₂	L ₃	h	ℓ	ホルダ型式 Holder type
16	48	24	10	—	14.2	30	SLC16
20	50	25	11	—	18.2	32	SLC20
25	56	32	12	17	23	39	SLC25
32	60	36	14	19	30	44	SLC32
40	70	40	—	—	38	48	SLC40
42	—	—	—	—	—	—	SLC42

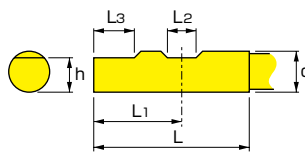

フラット面追加加工参考図
The reference drawing for making flat surface on the cutter shank.
偏心サイドロックホルダ用として追加加工を行う場合は、
下図の ℓ 及び h 寸法を参考にしてください。
Refer to dimension " ℓ " and " h " for making flat surface on the cutter shank for the excentric side lock holder.

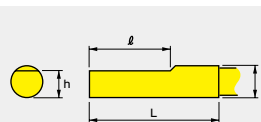

オイルホール付カッター用アーバ CUTTER ARBOR WITH SPINDLE-THROUGH COOLANT

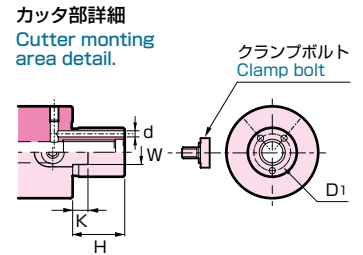
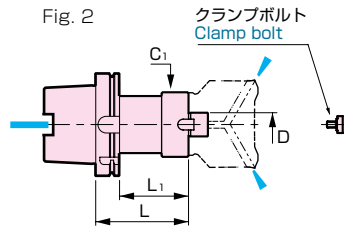
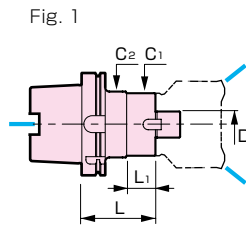

CODE	Fig.	カッタ径 Cutter dia	ϕD	L	L ₁	ϕC_1	ϕC_2	H	W	K	ϕD_1	ϕd	 Kg	クランプボルト Clamp bolt		
A125-FMH16 - 29- 90	1	32	16	90	33	29	42	17	8	5	12	2	3.9	M8 × 1.25		
-150				150	94								4.1			
- 37- 90				40	90								35		37	4.0
-150		150			95	4.4										
-200		200			144	4.7										
-FMH22 - 47- 90		50		22	90	35	47						53		18	10
-150			150		95	4.9										
-200			200		145	5.5										
-250			250		195	6.0										
-300			300		245	6.6										
- 60- 90			63		90	36	60	63							4.6	
-150					150	96									5.8	
-200					200	146									6.8	
-250					250	196									7.8	
-300					300	246									8.8	
-FMH22.225- 47- 90	50	22.225	90	35	47	53	17	8	3.5					4.2		
-150			150	96										4.9		
-200			200	144										5.4		
-250			250	195										6.0		
-300			300	246										6.6		
- 60- 90		63		90	36	60	63								4.6	
-150				150	96										5.7	
-200				200	146										6.6	
-250				250	196										7.5	
-300				300	246										8.4	
-FMH25.4 - 70- 90	80	25.4	90	61	70	-	22	9.5	5	18.5	3.5	5.0	5.0	MBF-M12		
-150			121	6.1												
-FMH31.75 - 76- 90	31.75		90	35	76	80	30	12.7	7	16	3	5.4	5.4	MBF-M16		
-150			150	95											7.2	
-200			200	145											8.7	
-250			250	195											10.2	
-300			300	244											11.7	
- 96- 90	2	100	38.1	90	61	96	-	34	10	5						
-150				150	121										7.3	
-200				200	171										8.6	
-250				250	221										9.8	
-300				300	271										11.0	
-FMH38.1 -100- 90	125			90	61	100		36	15.9	9	29	5	6.1	MBF-M20		
-150				150	121								7.5			
-200				200	171								8.8			
-250				250	221								10.0			
-FMH50.8 -100- 90	160			90	61			34	19.05	10	37.5	7	6.4	MBF-M24		
-150				150	121								7.9			
-200				200	171								9.2			
-250				250	221								10.4			

- 標準付属品 ● クランプボルト ● 回り止めキー ● クーラントダクト
- Standard accessories ● Clamp bolt ● Stopper key ● Coolant duct

正面フライスアーバ

FACE MILL ARBOR

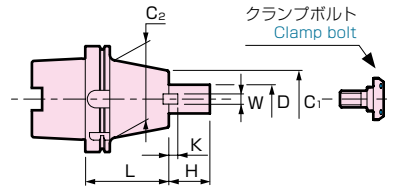

Metric

CODE	カッタ径 Cutter dia	φD(h6)	L	φC1	φC2	H	W	K	 Kg	クランプボルト Clamp bolt
A125-FMC22 - 55	50, 63, 80	22	55	45	53	18	10	5	4.0	MBP-M10C
-105			105						4.4	
-150			150						4.8	
-195			195						5.1	
-FMA25.4 - 55	76	25.4	55	50	80	22	9.5	7	4.0	MBC-M12
-105			105						5.4	
-135			135						6.0	
-195			195						7.3	
-FMA31.75 - 55	102	31.75	55	60	-	30	12.7	7	4.3	MBC-M16
-105			105						5.6	
-135			135						6.3	
-FMA38.1 - 55	127	38.1	55	80	-	34	15.9	9	4.6	MBC-M20
- 90			90						5.6	
-FMA50.8 - 55		50.8	55	100	-	36	19	10	5.3	MBC-M24
- 75			75						6.0	

Inch

CODE	カッタ径 Cutter dia	φD(h6)	L	φC1	φC2	H	W	K	 Kg	クランプボルト Clamp bolt
A125-FM 3/4 - 55	2.00	.7500	2.17	1.73	2.09	.68	.31	.14	4.0	3/8-24
-105			4.13						4.4	
-150			5.91						4.8	
-195			7.68						5.1	
-FM 1" - 55	2.50, 3.00	1.0000	2.17	2.19	3.15	.38	.18	7	4.0	1/2-20
-105			4.13						5.4	
-135			5.91						6.0	
-195			7.68						7.3	
-FM 1"1/4 - 55	4.00	1.2500	2.17	2.72	-	.94	.63	.30	4.3	5/8-18
-105			4.13						5.6	
-135			5.91						6.3	
-FM 1"1/2 - 55	4.00, 5.00	1.5000	2.17	3.86	-	.94	.63	.30	4.6	3/4-16
- 90			3.54						5.6	
-FM 2" - 55	6.00	2.0000	2.17	-	-	.94	.75	.37	5.3	1-14
- 75			2.95						6.0	

標準付属品 備考

- クランプボルト ●回り止めキー ●クーラントダクト
- クランプボルトはメーカーや型式によりタイプが異なり、付属のクランプボルトが取付かない場合があります。

Standard accessories

- Clamp bolt ●Drive key ●Coolant duct

Note

- The clamping bolt design depends on a maker and model no. The standard accessory clamp bolt may not fit it.

マイクロヘッド

MICRO HEAD

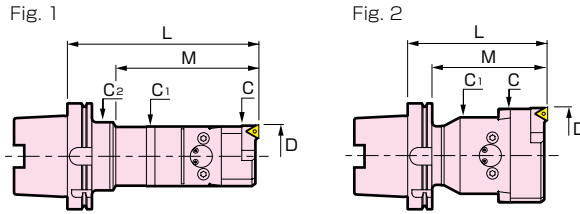

インサートチップ詳細
Insert detail.

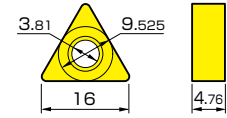

CODE	Fig.	加工範囲(D) Chuckling range	C	L	M	φC1	φC2	Kg	カートリッジ Cartridge	ISO CODE
A125-MBH 75-165	1	75~120	70	165	131	70	80	6.8	PTC12	TN**1604**
-225			80	225	168					
-285				285	228					
-315				315	258					
-MBH115-165	2	115~185	70	165	136	110	-	8.7		
-225			90	225	196					
-285				285	256					
-315				315	286					
-MBH180-165		180~250	70	165	165	153		9.4		
-225			90	225	225					
-285				285	285					
-MBH245-165		245~315	70	165	165	200		10.1		
-225			90	225	225					
-285				285	285					
-MBH310-165		310~380	70	165	165	255		11.1		
-225			90	225	225					

カートリッジ
Cartridge

MST CODE	ISO CODE	被削材質 Material
PTC12	PTGNL12CA	鋼 Steel

■備考 ●PTC:ピンロックタイプ
■Note ●PTC: Pin lock type



- オプション ●インサートチップ ●カートリッジ ●クーラントスルーシステム
- 標準付属品 ●T型レンチ ●クーラントダクト
- 備考 ●ドライブキー溝と刃先は同位相です。
- 注意事項 ●各スライド部の互換性はありません。
- Option ●Insert tip ●Cartridge ●Coolant-through
- Standard accessories ●T wrench ●Coolant duct
- Note ●Drive key slot and cutting direction are in alignment.
- Caution ●No interchangeability for the each slide.

アジャスタブルボーリングカッターヘッド

ADJUSTABLE BORING HOLDER

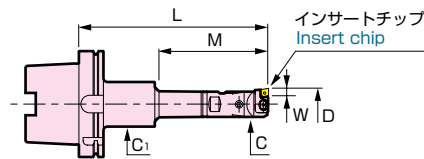

インサートチップ詳細
Insert detail.

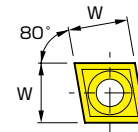

CODE	加工範囲(φD) Chuckling range	L	M	φC	φC1	W	Kg	ISO CODE
A125-ABH18C-165	24 ~ 32	165	80	18	53	6	4.3	CC**0602**
-225		225					5.1	
-ABH23C-165	29 ~ 34	165	100	23			4.2	
-225		225					4.9	
-ABH30C-165	38 ~ 54	165	130	30		9	4.2	CC**09T3**
-225		225					5.0	
-ABH40C-195	48 ~ 68	195	180	40			5.6	
-255		255					5.5	
-ABH50C-180	60 ~ 86	180	175	50	63		5.5	
-240		240					6.2	
-285		285					7.0	

- 備考 ●ドライブキー溝と刃先は同位相です。
- Note ●Drive key slot and cutting direction are in alignment.

ツールセッティングゲージ

TOOL SETTING GAUGE

TVA

TVM

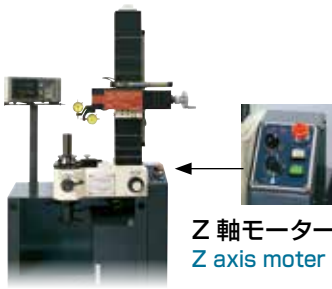

Z 軸モーター駆動
Z axis motor drive

Z 軸駆動部仕様
Z axis drive specification

電源 Voltage	100 / 110V
定格出力 Rating output	200W

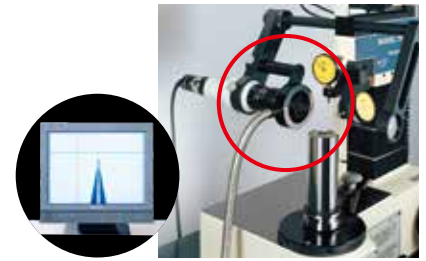
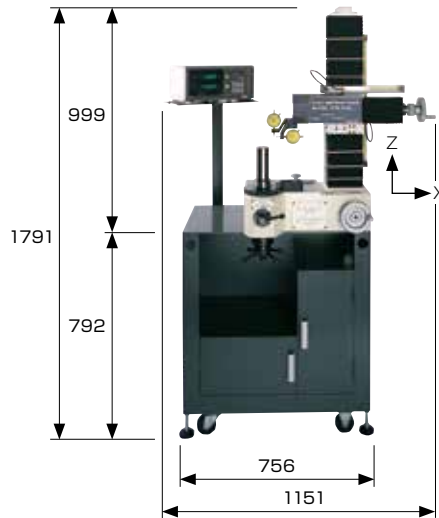

CCDカメラ標準付属
CCD camera delivers as standard accessory.

刃先をCCDカメラで拡大し、モニターで確認できます。
CCD camera upsizes the cutter edge, you can check it by a monitor.

CODE	X軸測定範囲 X axis measurement range	Z軸測定範囲 Z axis measurement range
TVM3052-1-A125	0 ~ φ300	55 ~ 440
TVA3052-1-A125		

- 標準付属品
- スピンドル(A125-SPA)
 - ドロワー(DRA-A125)
 - テストバー
 - スピンドル吊棒(2本)
 - 油差し

- Standard accessories
- Spindle (A125-SPA)
 - Draw-bar (DRA-A125)
 - Test bar
 - Hanging bars (2pcs) for the spindle.
 - Greaser

テストバー

Test bar

CODE	φD	L
A125-TBB50-300	50	300

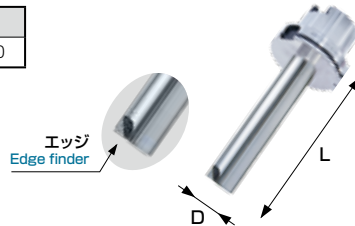

ツールセットアップスタンド

TOOL SET UP STAND

ビッグボーイ
Big Boy 125



CODE
BB-125

- 注意事項 ● 取付けボルトは付属していません。 取付時にはM12 ボルト 6ヶをご使用ください。
■ Caution ● No mounting bolts are provided. Use six M12 bolts for mounting.

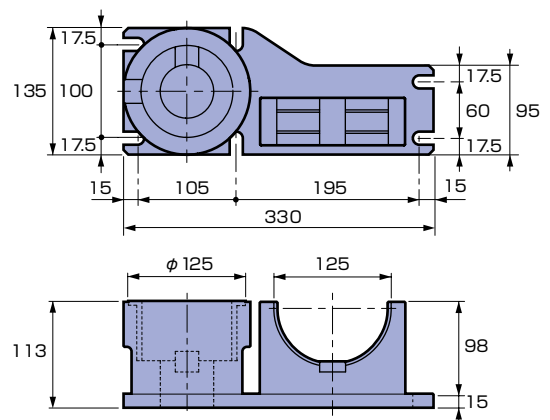

株式会社 **MST** コーポレーション

本社・工場 〒630-0142 奈良県生駒市北田原町1738
TEL: 0743(78)1184 FAX: 0743(78)3854
http://www.mst-corp.co.jp

MST corporation

1738 Kitatahara Ikoma Nara 630-0142 Japan
TEL:81-743-78-1931 FAX:81-743-78-3854
http://www.mst-corp.co.jp